



ARCHITECTURAL
SEALS

ARCHI-
TECTU
SEALS



We've been designing and manufacturing high performance sealing systems for almost 40 years.

And we're passionate about the products we make. Our dedicated R+D and testing facilities rigorously put our sealing systems through their paces – enabling us to enhance product form and function. We've built a strong reputation for design innovation; and for producing the highest quality sealing systems embracing acoustic, smoke, fire and thermal containment; as well as accessibility.

Respected throughout the industry for our technical expertise, we play an active role in helping to shape standards and best practice. We believe in providing excellent levels of customer service; and are at our best working in partnership with you.

The Lorient Architectural Seals range incorporates a variety of complementary door sealing systems including perimeter seals, drop seals, threshold plates, door bottom seals plus much more. These seals can provide outstanding protection for all four sides of the door against sound, smoke, fire, rain, light, draughts, dust and even insects.

Manufactured to the highest quality standards, Lorient Architectural Seals have been designed and tested for a host of different applications in a variety of sectors throughout commercial, industrial and public buildings.

**MADE IN
BRITAIN** 



SEALING DOORS WORLDWIDE

The UK is home to our head office, manufacturing operation and dedicated R+D testing facility. Our UK & Europe head office supports operations around the world, delivering the best solutions locally to our customers across four continents.

By keeping abreast of technical developments and changes to regulations and standards across the world, we deliver the highest levels of expertise and support.

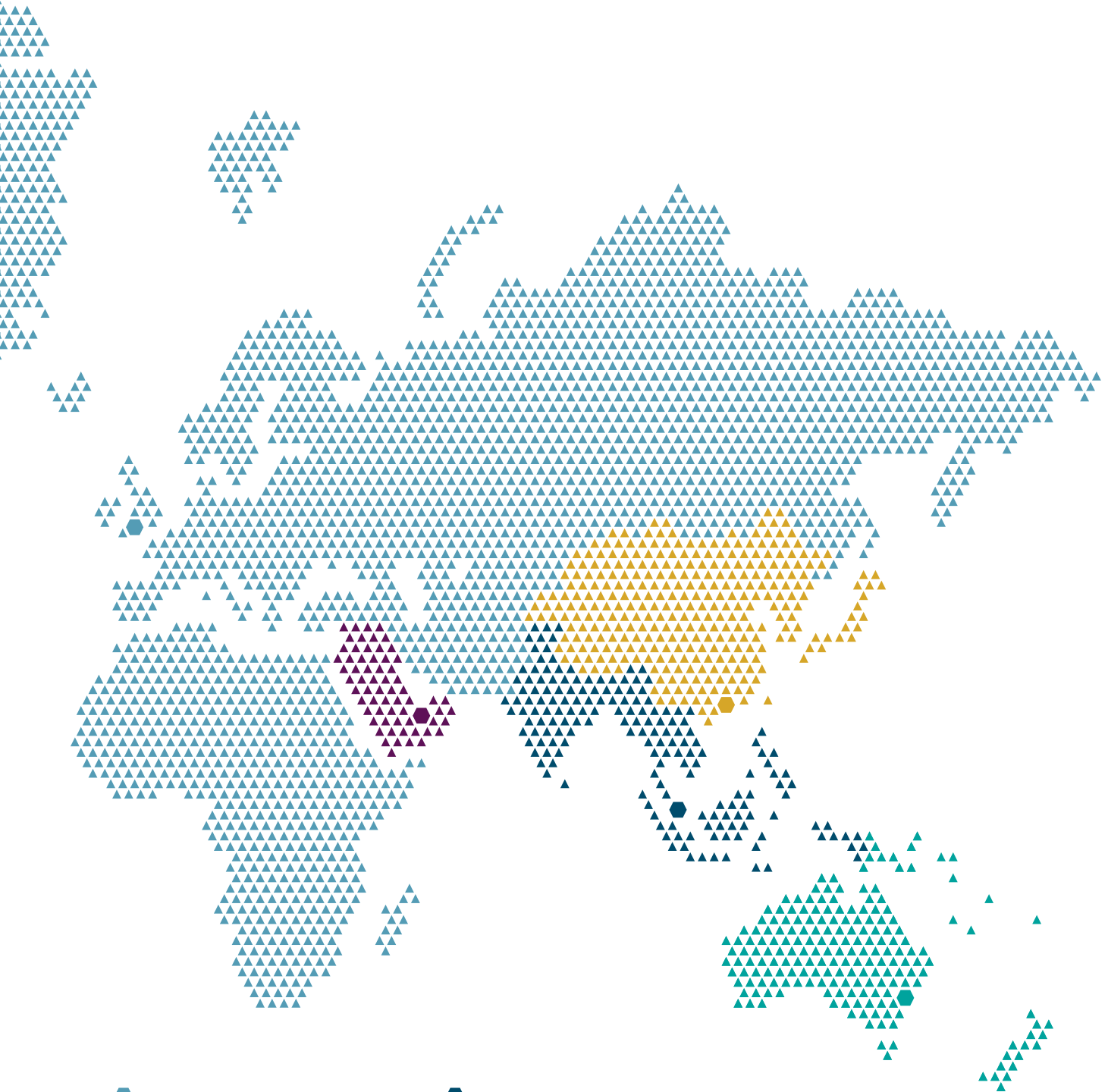

UNITED KINGDOM (HQ)
Lorient Polyproducts Ltd
T: +44 (0) 1626 834252
E: mktg@lorientuk.com



AUSTRALIA
Lorient PTY Ltd
T: +61 (02) 9907 6221
E: sales@lorientau.com.au



HONG KONG
Lorient Pacific Ltd
T: +852 2505 0328
E: sales@lorienthk.com



SINGAPORE
Lorient Southeast Asia PTE Ltd
T: +65 6270 1279
E: sales@lorient.com.sg



UAE
Lorient Gulf Building Materials LLC
T: +9714 883 7206
E: sales@lorientgulf.ae



USA
Lorient North America Ltd
T: +1 859 252 7441
E: inquiries@lorientna.com

REGULATIONS + REQUIREMENTS

With today's applications demanding more performance than ever from doors, a Lorient sealing system provides an integrated solution for acoustic, smoke, fire, thermal containment; and ease of access.

Meeting the requirements

Building Regulations exist to ensure the safety and comfort of everyone using a building. Various documents demonstrate the usual way of meeting the requirements of the Building Regulations and in many cases give specific guidance on acoustic containment, accessibility and fire and smoke containment.

Relevant Requirements

Sound:

Guidance and requirements for sound containment are found in Approved Document E (England), Approved Document E (Wales), Technical Booklet G (N. Ireland) and Technical Handbook Section 5 (Scotland).

Document E gives specific acoustic performance requirements for door assemblies in a number of situations.

In "dwelling-houses, flats and rooms for residential purposes" (Requirement E1), a minimum acoustic performance of Rw 29dB is stated.

Further clauses in Approved Document E (2.26, 4.20 and 6.6) relate this requirement to door assemblies:

"Ensure that any door has good perimeter sealing (including the threshold where practical), and a minimum mass per unit area of 25kg/m², or a minimum sound reduction index of Rw 29dB (measured according to BS EN ISO 10140-2: 2010 and rated accordingly to BS EN ISO 717-1: 2013). The door may also satisfy the Requirements of Building Regulation Part B – Fire safety."

Approved Document E also covers acoustic conditions in schools. Requirement E4 states:

"Each room or other space in a school building shall be designed and constructed in such a way that it has the acoustic conditions and the insulation against disturbance by noise appropriate to its intended use."

Section 8 of Document E recognises Building Bulletin 93, "The Acoustic Design of Schools" as an Approved Document, and the normal way of satisfying requirement E4.

This document gives "performance standards for airborne sound insulation between circulation spaces and other spaces used by students – minimum sound reduction index Rw":

*"All spaces except music rooms 30 dB
Music rooms 35 dB."*

It's therefore now essential to take into account the requirements of Approved Document E when specifying and installing sealing systems for door assemblies.

Relevant Standards

The British Standards below refer to seals for doors:

- ▶ BS EN ISO 10140-2: 2010: Acoustics – Laboratory measurement of sound insulation of building elements. Measurement of airborne sound insulation
- ▶ BS EN ISO 717-1: 2013: Acoustics – Rating of sound insulation in buildings and of building elements
- ▶ Sound reduction index of joints according to BS EN ISO 10140-1: 2016 (Annex J)

- ▶ ASTM-E413 Classification for rating sound insulation

Many acoustic door assemblies will also need to provide fire and smoke containment. This means that the door assembly will need to have several test reports:

- ▶ Fire resistance under the conditions of BS 476-22: 1987; BS EN 1634-1: 2014
- ▶ Smoke control under the conditions of BS 476-31.1: 1983; BS EN 1634-3: 2004
- ▶ Acoustic performance under the conditions of BS EN ISO 10140-2: 2010, rated in accordance with BS EN ISO 717-1: 2013

Fire and Smoke

- ▶ BS 9999: 2017 Fire safety in the design, management and use of buildings. Code of practice

Approved Document B (England), Approved Document B (Wales), Technical Booklet E (N. Ireland), Technical Handbook Section 2 (Scotland).

The requirements for fire and smoke containment with regard to 'means of escape' are contained in the above documents.

These documents specify that practically all internal fire resistant door assemblies are also required to prevent the passage of cold smoke.

Please bear in mind that performance in relation to cold smoke needs to be considered separately from performance in relation to fire and hot smoke, and a separate test report is called for.

Accessibility

- ▶ BS 8300: 2009+A1: 2010 Design of buildings and their approaches to meet the needs of disabled people. Code of Practice

Please note: This standard is currently under revision. BS 8300 gives guidance on good practice in the design of domestic and non-domestic buildings and their approaches, allowing them to be conveniently used by disabled persons.

Approved Document M (England and Wales), Technical Booklet R (N. Ireland), Technical Handbook Section 4 (Scotland).

These documents specify accessibility for everyone using buildings. They detail the size and location of glazed panels in doors in various situations, in order to promote safety and accessibility. Visual contrast on the leading edge of doors is also included, as are opening and closing forces for ease of door operation, threshold height and door width requirements.

In addition to providing acoustic insulation and fire/smoke protection, doors must allow free passage. It is crucial that the sealing system fitted to a door assembly should have minimal effect on the opening and closing operation of the assembly.



▲ Images: Lorient Batwing® & LAS8014 si drop seal

TESTING + TECHNICAL SERVICES

We've built our reputation on the quality and dependability of our products, and our investment in R+D has played a pivotal role in keeping our products at the forefront of our industry. Our dedicated Testing and Technical Services division has established itself as an important facility for manufacturers and designers of doors, windows, glazing systems and hardware, to name just a few.

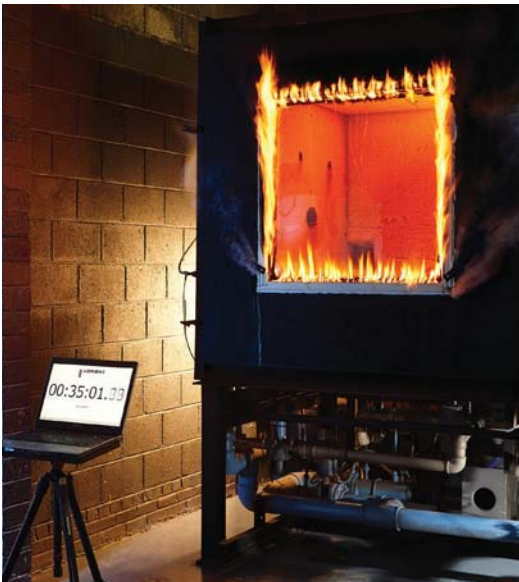

Our state-of-the-art acoustic transmission suite features the latest sound measurement technology. It was designed and purpose-built to meet the requirements of BS EN ISO 10140-2: 2010: – Laboratory measurement of sound insulation of building elements.

Alongside full-scale acoustic testing, we are also able to offer:

- ▶ Fire testing (indicative)
- ▶ Smoke leakage
- ▶ Air leakage
- ▶ Mechanical cycling
- ▶ Environmental chamber analysis
- ▶ Site-based testing
- ▶ Attendance at external fire tests
- ▶ Consultancy services
- ▶ Fire door inspection services

**Call our Technical Services team
+44 (0) 1626 834252**



▼ COMPRESSION SEALS

A variety of durable, flexible and lightweight seals that are easy to fit to the perimeter of timber doors and window frames.

Compression seals are ideal for new build or retrofit applications.



COMPRESSION SEALS

LAS1020, LAS1030 & LAS1040

LIGHT DUTY

Superior quality, self-adhesive door and window frame strips, which provide an effective acoustic compression seal. Lightweight and flexible. Quick and easy installation. Help to reduce audible vibration between door, window and frame.



LAS1020



LAS1030



LAS1040



LAS1020

COMPRESSION SEALS

SYSTEM SPECIFICATIONS

Performance

- ▶ Protects against sound, weather, draught and light.

Location

- ▶ Mounted on the doorstep for single swing doors.

Use with

- ▶ Practically any threshold seal.

Min/max gap size

- ▶ LAS1020 - 3mm/4mm.
- ▶ LAS1030 - 2mm/3.5mm.
- ▶ LAS1040 - 2mm/3mm.

Seal material

- ▶ LAS1030 and LAS1040 - soft EPDM foam.
- ▶ LAS1020 - soft PVC foam.

Standard lengths

- ▶ LAS1020 - 6m and 100m rolls.
- ▶ LAS1030 - 6m and 100m rolls.
- ▶ LAS1040 - 6m rolls.

Fixing

- ▶ Self-adhesive tape.
- ▶ Note: contact surfaces must be clean, smooth and, if painted, well cured.

Colours

- ▶ White or brown.

COMPRESSION SEALS

LAS1050

MEDIUM DUTY **45dB**

Durable, silicone compression seal for acoustic performance. Seal push fits quickly and easily into a 12mm wide x 12mm deep groove. No mechanical fixings/screws required.



COMPRESSION SEALS

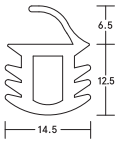

▶ LAS1050



SYSTEM SPECIFICATIONS

Test evidence

- ▶ Acoustic: BS EN ISO 10140-2: 2010 (up to Rw 45dB).

Performance

- ▶ Protects against sound, draught and light.

Location

- ▶ Head and jambs of single swing doors.

Use with

- ▶ Practically any threshold seal.

Min/max gap size

- ▶ 2mm/4mm.

Seal material

- ▶ Flexible silicone rubber.

Standard lengths

- ▶ 100m reels.

Fixing

- ▶ Interference fit into 12mm x 12mm preformed steel door frame rebate.

Colours

- ▶ White, grey, dark brown or black.

COMPRESSION SEALS

LAS1025 & LAS1046

LIGHT DUTY

Superior quality, self-adhesive profiles for door and window frames, in a choice of styles, which provide an acoustic compression seal. Lightweight and flexible. Quick and easy installation.

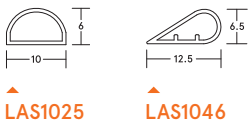

LAS1025

LAS1046



LAS1046

COMPRESSION SEALS

SYSTEM SPECIFICATIONS

Performance

- ▶ Protects against sound, weather, draught and light.

Location

- ▶ LAS1025 – mounted on doorstep or can be recessed by up to 2mm on single swing doors.
- ▶ LAS1046 – mounted on doorstep for single swing doors.

Use with

- ▶ Practically any threshold seal.

Min/max gap size

- ▶ LAS1025 – 3mm/4mm (rebated).
- ▶ LAS1025 – 3mm/5.5mm (non-rebated).
- ▶ LAS1046 – 3mm/5mm.

Seal material

- ▶ LAS1025 – co-extruded elastomeric bulb with PVC spine.
- ▶ LAS1046 – silicone.

Standard lengths

- ▶ LAS1025 – 1m and 2.1m lengths.
- ▶ LAS1046 – 100m reels.

Fixing

- ▶ Self-adhesive tape.
- ▶ Note: contact surfaces must be clean, smooth and, if painted, well cured.

Colours

- ▶ LAS1025 – white or brown.
- ▶ LAS1046 – white, dark brown or black.

Accreditation



(R27972)
LAS1046
Dark brown & black

COMPRESSION SEALS

LAS1002 si, LAS1005 si & LAS1009 si

LIGHT DUTY **30dB**

Durable, kerf-fitting bulb seals of varying sizes for doors and window frames, which provide a compression seal. Lightweight and flexible. Quick and easy installation.



COMPRESSION SEALS



LAS1005 si

LAS1002 si

LAS1009 si



LAS1002 si

SYSTEM SPECIFICATIONS

Test evidence

- ▶ Acoustic: BS EN ISO 10140-2: 2010 (up to Rw 30dB).

Performance

- ▶ Protects against sound, smoke, draught and light.

Location

- ▶ Head and jambs of single swing doors.

Use with

- ▶ Practically any threshold seal.

Min/max gap size

- ▶ LAS1005 - 3mm/4mm.
- ▶ LAS1002 - 4mm/6mm.
- ▶ LAS1009 - 5mm/8mm.

Seal material

- ▶ Flexible silicone rubber.

Standard lengths

- ▶ 100m reels.

Fixing

- ▶ Interference fit into a kerf 2mm wide and minimum 4mm deep.

Colours

- ▶ Grey, dark brown or black. Other colours available on request.

COMPRESSION SEALS

LAS1606

LIGHT DUTY

A light-weight bulb type buffer seal with a semi-rigid spine for kerf fitting. Suitable for external use and locations where moisture ingress may occur. Quick and easy installation.



LAS1606



COMPRESSION SEALS

SYSTEM SPECIFICATIONS

Performance

- ▶ Protects against sound, weather, draught and light.

Location

- ▶ Head and jambs of single swing doors.

Use with

- ▶ Practically any threshold seal.

Min/max gap size

- ▶ 3mm/6mm.

Seal material

- ▶ Co-extruded elastomeric bulb with PVC spine.

Standard lengths

- ▶ 5m and 10m rolls.

Fixing

- ▶ Interference fit into a kerf 2mm wide and minimum 6mm deep.

Colours

- ▶ White, grey, light brown or black.

DOOR BOTTOM SEALS



A range of versatile and hardwearing door bottom seals, that seal the gap between the bottom of the door and the floor.

They can be surface mounted or concealed in a rebated groove at the bottom of the door leaf. Use with a threshold plate for the optimum sealing solution.

DOOR BOTTOM SEALS

LAS3001 si, LAS3002 si & LAS3003 si

MEDIUM DUTY **31dB** **32dB**

Medium duty door bottom seals with slide-in gaskets ideal for acoustic and smoke containment.

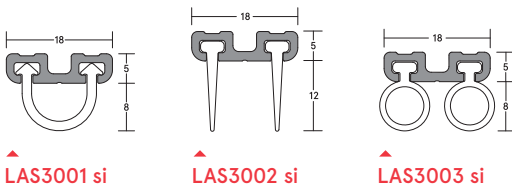

LAS3001 si

LAS3002 si

LAS3003 si



LAS3001 si (shown with LAS4001)

DOOR BOTTOM SEALS

SYSTEM SPECIFICATIONS

Test evidence

- ▶ Acoustic: BS EN ISO 10140-2: 2010. LAS3001 si Rw 32dB, LAS3002 si Rw 31dB.

Performance

- ▶ Protects against sound, smoke, weather, draught, light and insects.

Location

- ▶ Single and double swing doors.

Use with

- ▶ Practically any threshold plate.

Min/max gap size

- ▶ LAS3001 si – 6mm/13mm.
- ▶ LAS3002 si – 10mm/17mm.
- ▶ LAS3003 si – 7mm/13mm.

Seal material

- ▶ Flexible silicone rubber.

Standard lengths

- ▶ 1m and 2.1m. Other lengths to special order.

Fixing

- ▶ Face-fixed, semi-rebated or fully rebated.
- ▶ Self-tapping wood screws are supplied (self-drilling and self-tapping screws for metal construction available on request).
- ▶ Fixing holes are pre-drilled. Once the aluminium carrier is fixed, the flexible silicone rubber gasket slides easily into place.
- ▶ Note: these seals cannot be adjusted once fitted.

Finish

- ▶ Silver anodised aluminium with grey silicone insert.

Accreditation



(R27972)

LAS3001 si & LAS3002 si

DOOR BOTTOM SEALS

LAS3004 si

HEAVY DUTY

A heavy duty, blade-type door bottom seal for easy face-fixed installations. Slimline aesthetic design with flexible cover strip to conceal fixings. It can easily accommodate a range of larger threshold gap sizes. Hard wearing and durable seal.

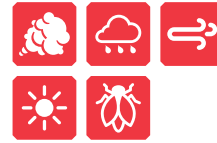

DOOR BOTTOM SEALS

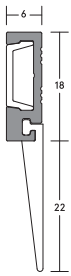

LAS3004 si



LAS3004 si (shown with LAS4010)

SYSTEM SPECIFICATIONS

Performance

- ▶ Protects against smoke, weather, draught, light and insects when fitted with a suitable threshold seal.

Location

- ▶ Single and double leaf doors.
- ▶ Up and over garage doors.
- ▶ Roller shutter doors.

Use with

- ▶ Practically any threshold plate.

Min/max gap size

- ▶ 10mm/22mm.

Seal material

- ▶ Flexible silicone rubber.

Standard lengths

- ▶ 1m and 2.1m. Other lengths to special order.

Fixing

- ▶ Self-tapping wood screws are supplied (self-drilling and self-tapping screws for metal construction available on request).
- ▶ Fixing holes are pre-drilled and slotted to allow the seals to be adjusted and positioned accurately.

Finishes

- ▶ Silver anodised aluminium with grey cover strip and grey silicone rubber blade.
- ▶ Bronze anodised aluminium with black cover strip and black silicone rubber blade.

DOOR BOTTOM SEALS

LAS3005 & LAS3006

MEDIUM DUTY

Medium duty door bottom seals with a wiping action to seal gaps from draughts or rain. Flexible, plus quick and easy to install.

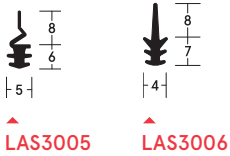
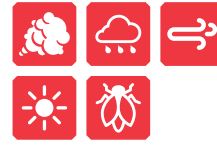

LAS3005

LAS3006



LAS3005 (shown with LAS4002)

DOOR BOTTOM SEALS

SYSTEM SPECIFICATIONS

Performance

- ▶ Protects against smoke, weather, draught, light and insects when fitted with a suitable threshold seal.

Location

- ▶ Single and double leaf doors.

Use with

- ▶ Practically any threshold plate.

Min/max gap size

- ▶ 4mm/7mm.

Seal material

- ▶ EPDM material.

Standard lengths

- ▶ 100m coils. Other lengths to special order.

Fixing

- ▶ Interference fit into appropriate sized kerf.

Finish

- ▶ Black.

DOOR BOTTOM SEALS

LAS3007 si

HEAVY DUTY

A heavy duty, multi-blade weather proof seal, which can be fitted without removing the door, and can be used with a choice of threshold plates. Concealed fixings, pre-drilled and slotted holes on LAS3007 si provide easy adjustment. Durable, anodised aesthetic finish.

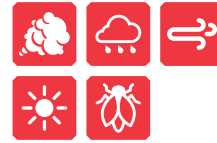

DOOR BOTTOM SEALS

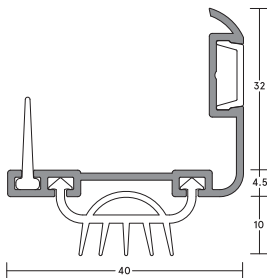

LAS3007 si



LAS3007 si (shown with LAS4010)

SYSTEM SPECIFICATIONS

Performance

- ▶ Protects against smoke, weather, draught, light and insects when fitted with a suitable threshold seal.

Location

- ▶ Single and double leaf doors.

Use with

- ▶ Practically any threshold plate.

Min/max gap size

- ▶ 16mm/22mm.

Seal material

- ▶ Flexible silicone rubber.

Standard lengths

- ▶ 1m and 2.1m. Other lengths to special order.

Fixing

- ▶ Self-tapping wood screws are supplied (self-drilling and self-tapping screws for metal construction available on request).
- ▶ Fixing holes are pre-drilled and slotted to allow the seals to be adjusted and positioned accurately. A PVC cover strip to conceal fixings is supplied.

Finishes

- ▶ Silver anodised aluminium with grey cover strip and grey silicone rubber blade.
- ▶ Bronze anodised aluminium with black cover strip and black silicone rubber blade.

Accreditation



(R27972)

DOOR BOTTOM SEALS

LAS3008 si

MEDIUM DUTY

A multi-blade, storm-proof seal combination consisting of the LAS3007 si door bottom seal and LAS4015 threshold plate. Durable, anodised aesthetic finish. It can be fitted without removing the door. Concealed fixings, pre-drilled and slotted holes on LAS3007 si for easy adjustment.

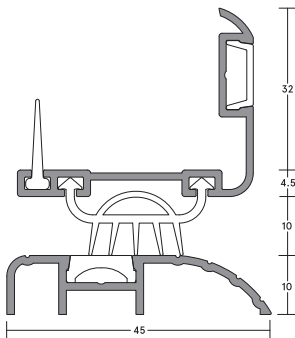

LAS3008 si

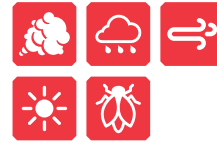

DOOR BOTTOM SEALS

SYSTEM SPECIFICATIONS

Performance

- ▶ Protects against smoke, weather, draught, light and insects when fitted with a suitable threshold seal.

Location

- ▶ Single swing doors.

Use with

- ▶ Practically any threshold plate.

Min/max gap size

- ▶ 26mm/32mm.

Seal material

- ▶ LAS3007 si – Flexible silicone rubber.
- ▶ LAS4015 – Aluminium with PVC cover strip.

Standard lengths

- ▶ 1m and 2.1m. Other lengths to special order.

Fixing

- ▶ LAS3007 si – Self-tapping wood screws are supplied (self-drilling and self-tapping screws for metal construction available on request). Fixing holes are predrilled and slotted to allow the seals to be adjusted and positioned accurately.
- ▶ A PVC cover strip to conceal fixings is supplied.
- ▶ LAS4015 – Fixing screws are supplied. PVC cover strip to conceal fixings is supplied.

Finishes

- ▶ LAS3007 si – Silver anodised aluminium with grey cover strip and grey silicone rubber gasket.
- ▶ LAS3007 si – Bronze anodised aluminium with black cover strip and black silicone rubber gasket.
- ▶ LAS4015 – Silver anodised aluminium with grey cover strip or bronze anodised aluminium with black cover strip.

DOOR BOTTOM SEALS

LAS3009 si

MEDIUM DUTY

Medium duty door bottom seal with slide-in gaskets. Suitable for single and double swing doors, as well meeting stiles (one leaf only).



DOOR BOTTOM SEALS

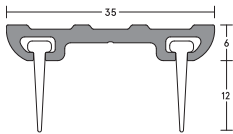

LAS3009 si



LAS3009 si (shown with LAS4002)

SYSTEM SPECIFICATIONS

Performance

- ▶ Protects against sound, smoke, weather, draught, light and insects when fitted with a suitable threshold seal.

Location

- ▶ Single and double swing doors.

Use with

- ▶ Practically any threshold plate.

Min/max gap size

- ▶ 16mm/22mm.

Seal material

- ▶ Flexible silicone rubber.

Standard lengths

- ▶ 1m and 2.1m. Other lengths to special order.

Fixing

- ▶ Self-tapping wood screws are supplied (self-drilling and self-tapping screws for metal construction available on request).
- ▶ Fixing holes are pre-drilled. Once the aluminium carrier is fixed, the rubber gasket slides easily into place.
- ▶ Note: these seals cannot be adjusted once fitted.

Finishes

- ▶ Silver anodised aluminium with grey silicone rubber blade.
- ▶ Bronze anodised aluminium with black silicone rubber blade.

DOOR BOTTOM SEALS

LAS3050

HEAVY DUTY

A durable door bottom seal with a grade 304 stainless steel fixing plate. Low maintenance and extremely resistant to weathering or aggressive commercial environments. Impervious to most chemicals, solvents, cleaning fluids and disinfectants. Quick and easy installation.

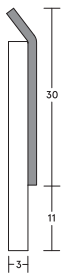
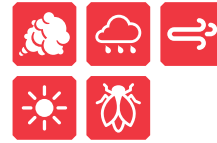

▲ LAS3050



▲ LAS3050 (shown with LAS4050)

DOOR BOTTOM SEALS

SYSTEM SPECIFICATIONS

Performance

- ▶ Protects against smoke, weather, draught, light and insects when fitted with a suitable threshold seal.

Location

- ▶ Single and double leaf doors.
- ▶ Up and over garage doors.
- ▶ Roller shutter doors.

Use with

- ▶ Any stainless steel threshold plate.

Min/max gap size

- ▶ 5mm/10mm.

Seal material

- ▶ Foamed silicone rubber.

Standard lengths

- ▶ 1m and 2.1m. Other lengths to special order.

Fixing

- ▶ Fixing screws are supplied, fixing holes are pre-drilled and slotted to allow the seals to be adjusted and positioned accurately.

Finishes

- ▶ Brushed stainless steel with grey silicone rubber.
- ▶ Polished stainless steel (non-standard - charges and lead times apply).

THRESHOLD PLATES + RAMPS

Hardwearing aluminium and stainless steel threshold plates and ramps that are affixed to the sill beneath the door. Threshold plates provide a firm and effective sealing surface for threshold seals to rest against, while also covering the join between different flooring materials.

Threshold ramps feature a gentle sloping gradient to accommodate differences in floor heights.

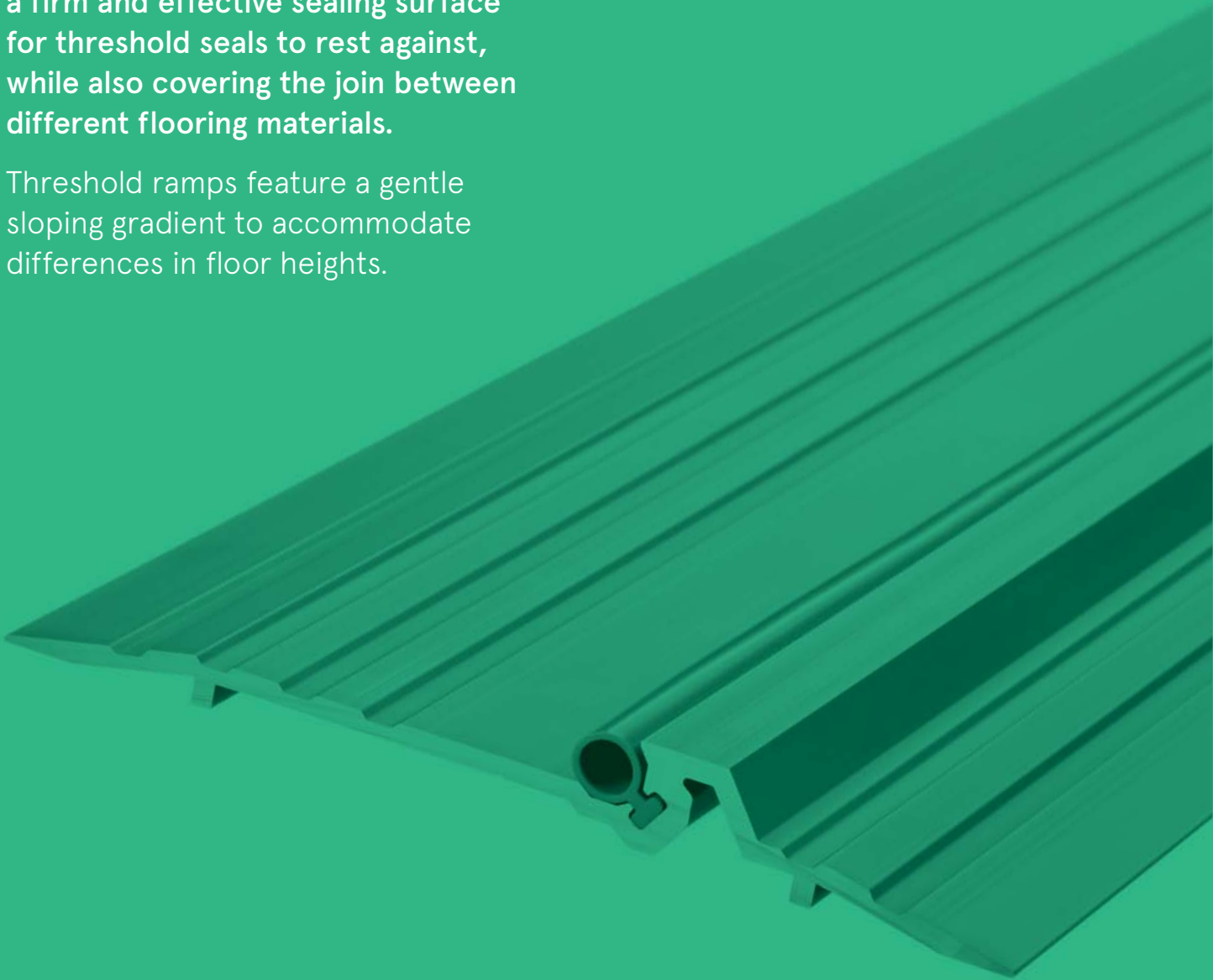

LAS4001 & LAS4002

MEDIUM DUTY

Medium duty, gently curved low-profile aluminium threshold plates. These plates can increase the effectiveness of threshold seals by creating a firmer gasket contact. Durable anodised aesthetic finish. Quick and easy installation.

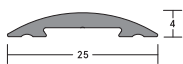
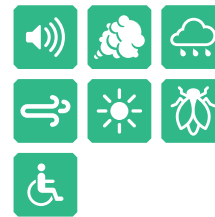

LAS4001

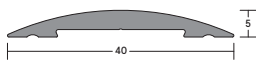

LAS4002



LAS4001

THRESHOLD PLATES + RAMPS

SYSTEM SPECIFICATIONS

Performance

- ▶ Protects against sound, smoke, weather, draught, light and insects when fitted with a suitable threshold seal.
- ▶ Provides an even surface underneath the door; suitable for wheeled traffic.

Location

- ▶ Single and double swing doors.

Use with

- ▶ Practically any drop or door bottom seal.

Material

- ▶ Aluminium.

Standard lengths

- ▶ 1m and 2.1m. Other lengths to special order.

Fixing

- ▶ Fixing screws are supplied.

Finishes

- ▶ Silver anodised aluminium.
- ▶ Bronze anodised aluminium.
- ▶ Black and light bronze anodised aluminium (non-standard - charges and lead times apply).
- ▶ Other powder-coated colour finishes (non-standard - charges and lead times apply).

Accreditation



(R27972)

THRESHOLD PLATES + RAMPS

LAS4010, LAS4011, LAS4012 & LAS4013

MEDIUM DUTY

Medium duty, low profile aluminium threshold plates, only 6mm high. Ideal for wheeled traffic. These plates can increase the effectiveness of threshold seals by creating a firmer gasket contact. Durable anodised aesthetic finish. Quick and easy installation.



THRESHOLD PLATES + RAMPS

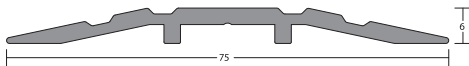

LAS4010

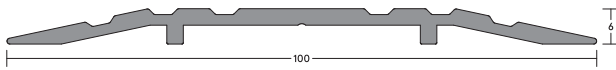

LAS4011

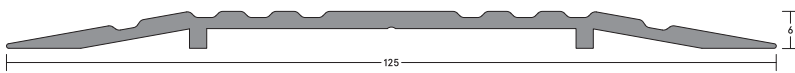

LAS4012

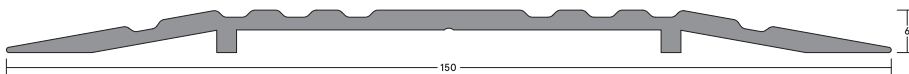

LAS4013



LAS4010

SYSTEM SPECIFICATIONS

Performance

- ▶ Protects against sound, smoke, weather, draught, light and insects when fitted with a suitable threshold seal.
- ▶ Provides an even surface underneath the door; suitable for wheeled traffic.

Location

- ▶ Single and double swing doors.

Use with

- ▶ Practically any drop or door bottom seal.

Material

- ▶ Aluminium.

Standard lengths

- ▶ 1m and 2.1m. Other lengths to special order.

Fixing

- ▶ Fixing screws are supplied.

Finishes

- ▶ Silver anodised aluminium.
- ▶ Bronze anodised aluminium.
- ▶ Black and light bronze anodised aluminium (non-standard - charges and lead times apply).
- ▶ Other powder-coated colour finishes (non-standard - charges and lead times apply).

Accreditation



(R27972)

LAS4014 si

HEAVY DUTY **42dB**

Heavy duty, aluminium, stepped threshold plate featuring high performance silicone compression seal, which helps to prevent rain, draught, light and noise penetration. Can increase the effectiveness of threshold seals by creating a firmer gasket contact. Durable anodised aesthetic finish.

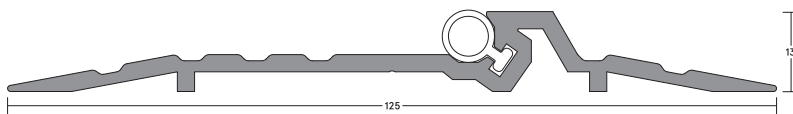

LAS4014 si



SYSTEM SPECIFICATIONS

Test evidence

- ▶ Acoustic: BS EN ISO 10140-2: 2010 (up to Rw 42dB).

Performance

- ▶ Meets smoke requirement: BS 9999: 2017.
- ▶ Protects against sound, smoke, weather, draught, light and insects.
- ▶ Provides an even surface underneath the door; suitable for wheeled traffic.

Location

- ▶ Single and double leaf outward opening doors.

Use with

- ▶ Practically any drop or door bottom seal.

Material

- ▶ Aluminium and silicone gasket.

Standard lengths

- ▶ 1m and 2.1m. Other lengths to special order.

Fixing

- ▶ Fixing screws are supplied.

Finishes

- ▶ Silver anodised aluminium with grey silicone rubber gasket.
- ▶ Bronze anodised aluminium with black silicone rubber gasket.
- ▶ Black and light bronze anodised aluminium (non-standard - charges and lead times apply).

- ▶ Other powder-coated colour finishes (non-standard - charges and lead times apply).

LAS4015

HEAVY DUTY

Heavy duty, aluminium threshold plate suitable for outward opening doors to prevent rain, draught and light. Can increase the effectiveness of threshold seals by creating a firmer gasket contact. Durable anodised aesthetic finish.



THRESHOLD PLATES + RAMPS

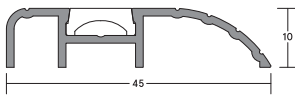

LAS4015



SYSTEM SPECIFICATIONS

Performance

- ▶ Protects against sound, smoke, weather, draught, light and insects when fitted with a suitable threshold seal.
- ▶ Provides an even surface underneath the door; suitable for wheeled traffic.

Location

- ▶ Single and double leaf outward opening doors.

Use with

- ▶ Practically any drop or door bottom seal.

Material

- ▶ Aluminium and PVC cover strip.

Standard lengths

- ▶ 1m and 2.1m. Other lengths to special order.

Fixing

- ▶ Fixing screws are supplied.

Finishes

- ▶ Silver anodised aluminium with grey cover strip.
- ▶ Bronze anodised aluminium with black cover strip.
- ▶ Black and light bronze anodised aluminium (non-standard - charges and lead times apply).
- ▶ Other powder-coated colour finishes (non-standard - charges and lead times apply).

Accreditation



(R27972)

LAS4050, LAS4055, LAS4060 & LAS4065

HEAVY DUTY

Heavy duty, grade 304 stainless steel threshold plates featuring a sleek design which, when used in conjunction with door bottom seals prevent rain and draught. Impervious to most chemicals, solvents, cleaning fluids and disinfectants.

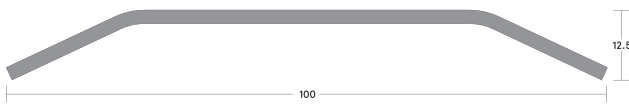

LAS4050

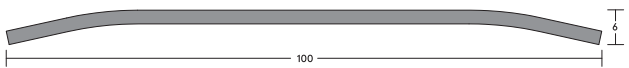

LAS4055

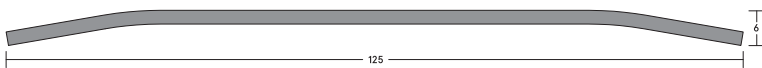

LAS4060

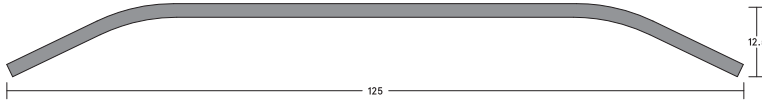

LAS4065



LAS4065

SYSTEM SPECIFICATIONS

Performance

- ▶ Impervious to most chemicals, solvents, cleaning fluids and disinfectants.
- ▶ Protects against sound, smoke, weather, draught, light and insects when fitted with a suitable threshold seal.
- ▶ Provides an even surface underneath the door; suitable for wheeled traffic

Location

- ▶ Single and double swing doors.

Use with

- ▶ Practically any drop or door bottom seal.

Material

- ▶ Grade 304 stainless steel.

Standard lengths

- ▶ 1m and 2.1m. Other lengths to special order.

Fixing

- ▶ Stainless steel fixing screws are supplied, fixing holes are pre-drilled.

Finish

- ▶ Brushed stainless steel.
- ▶ Polished stainless steel (non-standard - charges and lead times apply).

Accreditation



(R27972)

LAS4100

MEDIUM DUTY

Durable, medium duty aluminium threshold plate, 10mm high. It can increase the effectiveness of threshold seals by creating a firmer gasket contact. Quick and easy installation.

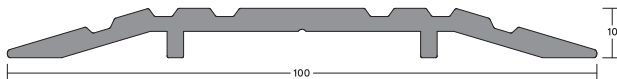

LAS4100



SYSTEM SPECIFICATIONS

Performance

- ▶ Protects against sound, smoke, weather, draught, light and insects when fitted with a suitable threshold seal.
- ▶ Provides an even surface underneath the door; suitable for wheeled traffic.

Location

- ▶ Single and double swing doors.

Use with

- ▶ Practically any drop or door bottom seal.

Material

- ▶ Aluminium.

Standard lengths

- ▶ 1m and 2.1m. Other lengths to special order.

Fixing

- ▶ Fixing screws are supplied.

Finishes

- ▶ Silver anodised aluminium.
- ▶ Bronze anodised aluminium.
- ▶ Black and light bronze anodised aluminium (non-standard - charges and lead times apply).
- ▶ Other powder-coated colour finishes (non-standard - charges and lead times apply).

BRUSH SEALS

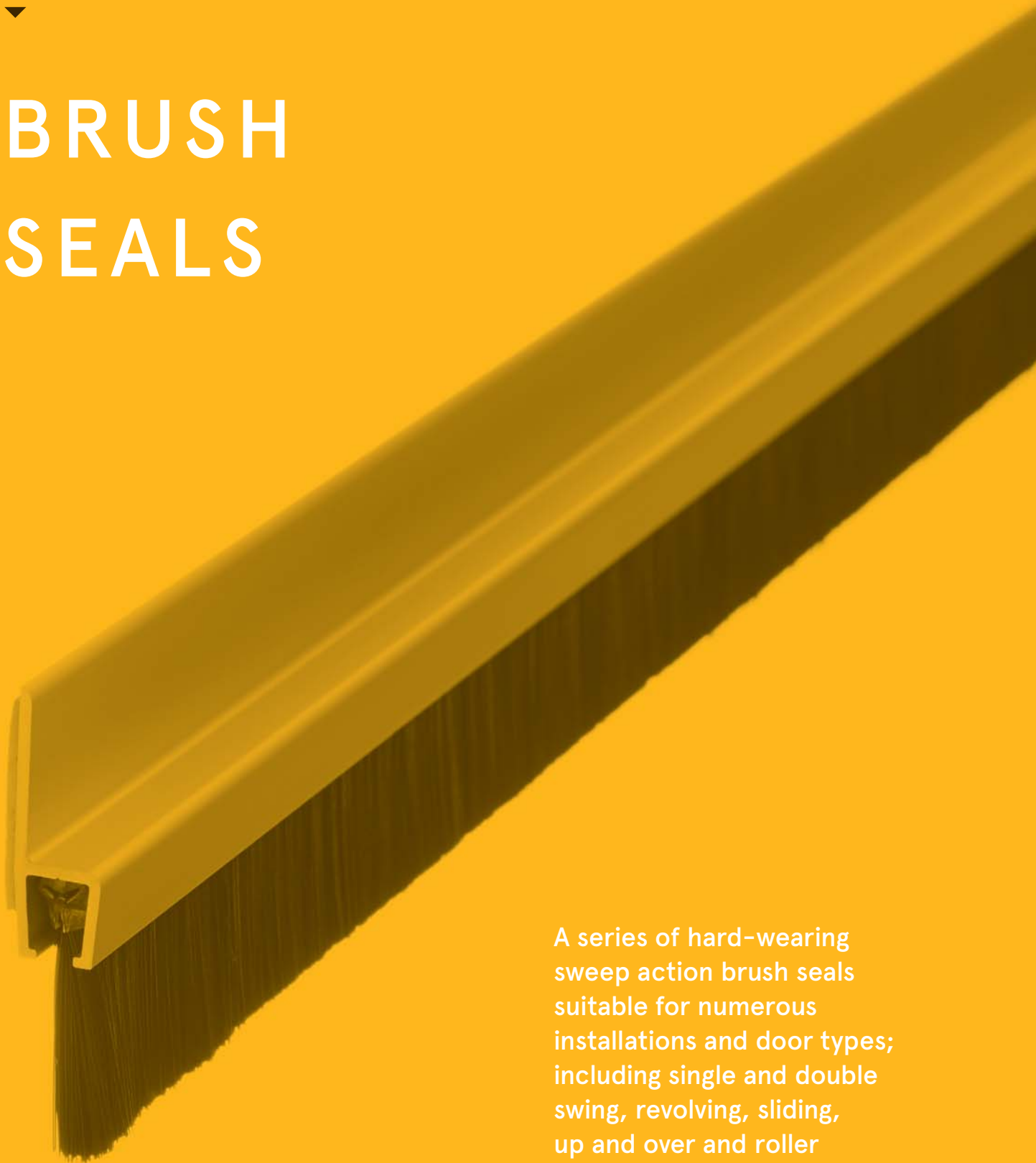

A series of hard-wearing sweep action brush seals suitable for numerous installations and door types; including single and double swing, revolving, sliding, up and over and roller shutter doors.

The independent filaments of the brush conform to irregular surfaces for a more complete seal.

BRUSH SEALS

LAS5010, LAS5015, LAS5020, LAS5025 & LAS5030

MEDIUM DUTY

Hard wearing, medium duty brush seals, suitable for various installations and door types. Nylon brush seals with aluminium carriers. Flexible and durable. Quick and easy installation.



BRUSH SEALS

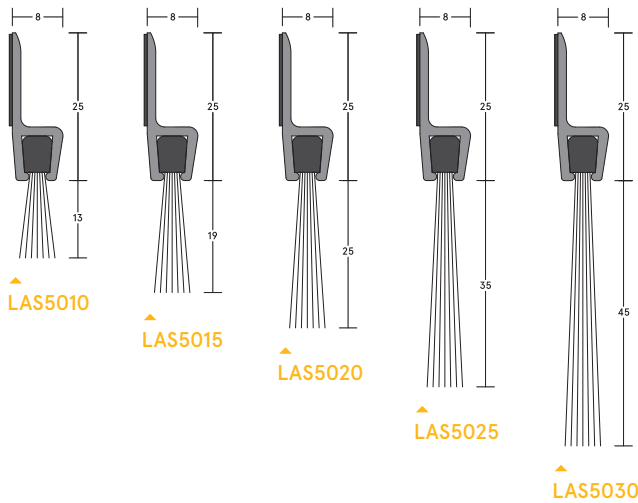

SYSTEM SPECIFICATIONS

Performance

- ▶ Meets smoke requirement: BS 9999: 2017.
- ▶ Protects against smoke, weather, draught and light.

Location

- ▶ Head, jambs, threshold and meeting stiles of single and double swing doors and sliding doors.
- ▶ Head, jambs and threshold of revolving doors, up and over doors, and roller shutter doors.

Use with

- ▶ Any threshold plate.

Min/max gap size

- ▶ LAS5010: 10mm/13mm.
- ▶ LAS5015: 13mm/19mm.
- ▶ LAS5020: 19mm/25mm.
- ▶ LAS5025: 25mm/35mm.
- ▶ LAS5030: 35mm/45mm.

Seal material

- ▶ Polypropylene brush filaments, UV stabilised.

Standard lengths

- ▶ 1m and 2.1m. Other lengths to special order.

Fixing

- ▶ Heavy duty self-adhesive tape.
- ▶ Screw fixing recommended: screws not supplied.

Finishes

- ▶ Silver anodised aluminium with black brush filaments.
- ▶ Bronze anodised aluminium with black brush filaments.

BRUSH SEALS

LAS5035, LAS5040, LAS5045, LAS5050 & LAS5055

HEAVY DUTY

Hard wearing, heavy duty brush seals, suitable for numerous installations and door types. Nylon brush seals with aluminium carriers. Flexible and durable. Quick and easy installation.

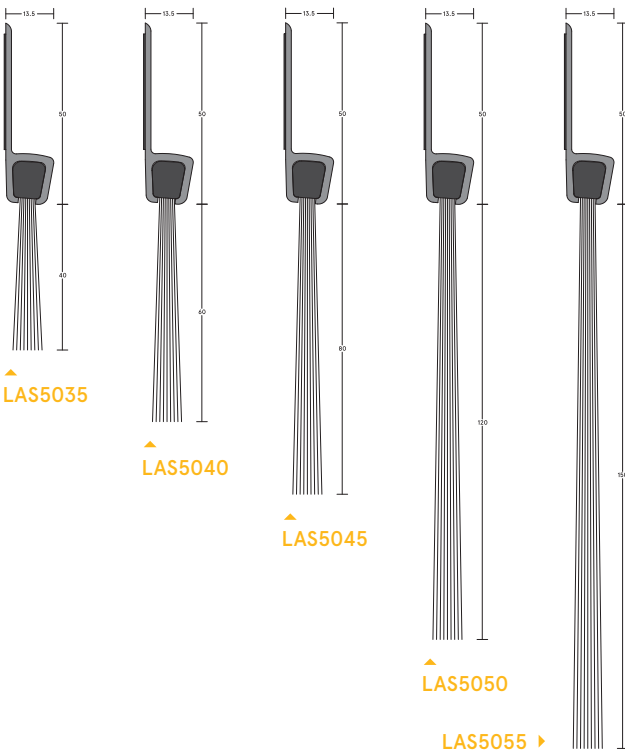

BRUSH SEALS

SYSTEM SPECIFICATIONS

Performance

- ▶ Meets smoke requirement: BS 9999: 2017.
- ▶ Protects against smoke, weather, draught and light.

Location

- ▶ Head, jambs, threshold and meeting stiles of single and double swing doors, and sliding doors.
- ▶ Head, jambs and threshold of revolving doors, up and over doors, and roller shutter doors.

Use with

- ▶ Any threshold plate.

Min/max gap size

- ▶ LAS5035: 20mm/40mm.
- ▶ LAS5040: 40mm/60mm.
- ▶ LAS5045: 60mm/80mm.
- ▶ LAS5050: 80mm/120mm.
- ▶ LAS5055: 120mm/150mm.

Seal material

- ▶ Polypropylene brush filaments, UV stabilised.

Standard lengths

- ▶ 1m and 2.1m.
- Other lengths to special order.

Fixing

- ▶ Heavy duty self-adhesive tape.
- ▶ Screw fixing recommended: screws not supplied.

Finishes

- ▶ Silver anodised aluminium with black brush filaments.
- ▶ Bronze anodised aluminium with black brush filaments.

BRUSH SEALS

LAS5060, LAS5065 & LAS5070

MEDIUM DUTY

Hard wearing, medium duty brush seals, with 90° aluminium carriers. Flexible and durable. Quick and easy installation.



BRUSH SEALS

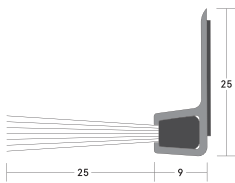

LAS5060

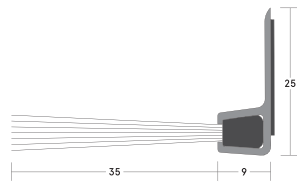

LAS5065

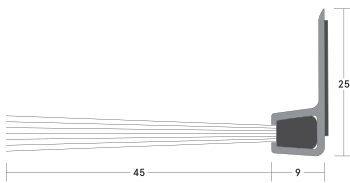

LAS5070



LAS5060

SYSTEM SPECIFICATIONS

Performance

- ▶ Protects against smoke, weather, draught and light.

Location

- ▶ Sliding doors.

Min/max gap size

- ▶ LAS5060: 24mm/30mm.
- ▶ LAS5065: 32mm/40mm.
- ▶ LAS5070: 39mm/50mm.

Seal material

- ▶ Polypropylene brush filaments, UV stabilised.

Standard lengths

- ▶ 1m and 2.1m. Other lengths to special order.

Fixing

- ▶ Heavy duty self-adhesive tape.
- ▶ Screw fixing recommended: screws not supplied.

Finishes

- ▶ Silver anodised aluminium with black brush filaments.
- ▶ Bronze anodised aluminium with black brush filaments.

BRUSH SEALS

LAS5075, LAS5080 & LAS5085

MEDIUM DUTY

Hard wearing, medium duty brush seals with 45° aluminium carriers. Flexible and durable. Quick and easy installation.

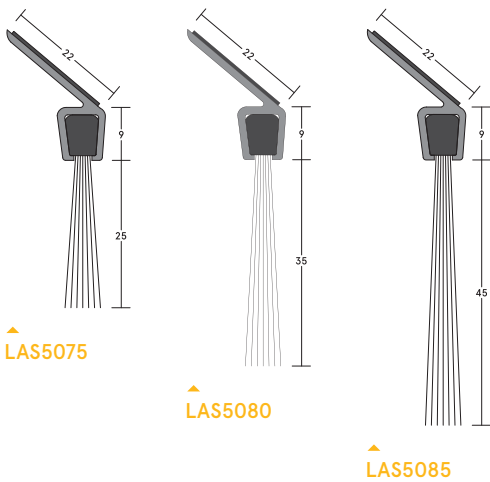

BRUSH SEALS

SYSTEM SPECIFICATIONS

Performance

- ▶ Protects against smoke, weather, draught and light.

Location

- ▶ A variety of industrial door applications requiring angled brushes.

Min/max gap size

- ▶ LAS5075: 19mm/25mm.
- ▶ LAS5080: 25mm/35mm.
- ▶ LAS5085: 35mm/45mm.

Seal material

- ▶ Polypropylene brush filaments, UV stabilised.

Standard lengths

- ▶ 1m and 2.1m. Other lengths to special order.

Fixing

- ▶ Heavy duty self-adhesive tape.
- ▶ Screw fixing recommended: screws not supplied.

Finishes

- ▶ Silver anodised aluminium with black brush filaments.
- ▶ Bronze anodised aluminium with black brush filaments.



MAGNETIC SEALS

Magnetic seals for use on both steel and timber doors. These seals provide a tight seal for door jambs and may also be used as a stop.

These seals have sufficient magnetic strength that latches may not be required.

MAGNETIC SEALS

LAS6001

MEDIUM DUTY **40dB**

A refrigeration-type vinyl magnetic strip in anodised aluminium housing. The strip holds the door closed so latches are not always required. Concealed fixings, pre-drilled and slotted holes for easy adjustment. Easily installed without removing the door and it can be used as a stop. Option to be supplied with magnetic keeper strip.

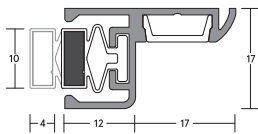

LAS6001



LAS6011



MAGNETIC SEALS

SYSTEM SPECIFICATIONS

Test evidence

- ▶ Acoustic: BS EN ISO 10140-2: 2010 (up to Rw 40dB).

Performance

- ▶ Protects against sound, smoke, draught and light.

Location

- ▶ Head and jams of single swing steel clad doors and timber doors (use with LAS6011).

Seal material

- ▶ LAS6001 – flexible insert with magnetic core.
- ▶ LAS6011 – PVC sleeve with magnetic insert.

Standard lengths

- ▶ 1m and 2.1m. Other lengths and single doorset packs consisting of 1 x 1m and 2 x 2.1m available to special order.

Fixing

- ▶ Self-tapping wood screws are supplied (self-drilling and self-tapping screws for metal construction available on request).
- ▶ Fixing holes are pre-drilled and slotted to allow the seals to be adjusted and positioned accurately. A PVC cover strip to conceal fixings is supplied.
- ▶ LAS6011 has an aggressive self-adhesive backing for fixing into a groove on timber doors.
- ▶ Note: order LAS6011 magnetic keeper strip for use with timber doors. Supplied with self-adhesive backing as standard.

Finishes

- ▶ LAS6001 – silver anodised aluminium with grey insert or bronze anodised aluminium with black insert.
- ▶ LAS6011 – brown, cream or maple PVC sleeve. Other colours, including woodgrain finishes to special order.

MAGNETIC SEALS

LAS6002

MEDIUM DUTY

A medium duty magnetic seal that has sufficient magnetic strength to hold the door closed so latches are not always required.

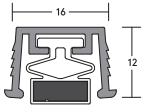

▲ LAS6002



SYSTEM SPECIFICATIONS

Performance

- ▶ Protects against smoke, draught and light.

Location

- ▶ Rebated meeting stiles of double leaf doors.
- ▶ Sliding doors.

Seal material

- ▶ Grey flexible insert with black magnetic core.

Standard lengths

- ▶ 2.1m. Other lengths to special order.

Fixing

- ▶ The aluminium profile is toothed to lock into a 16mm x 12mm groove.
- ▶ The magnetic seals are also 'locked' into prevent creeping.

Finish

- ▶ Silver anodised aluminium with grey insert. Black insert to special order.
- ▶ Note: not suitable where centre latching is required.

PERIMETER SEALS

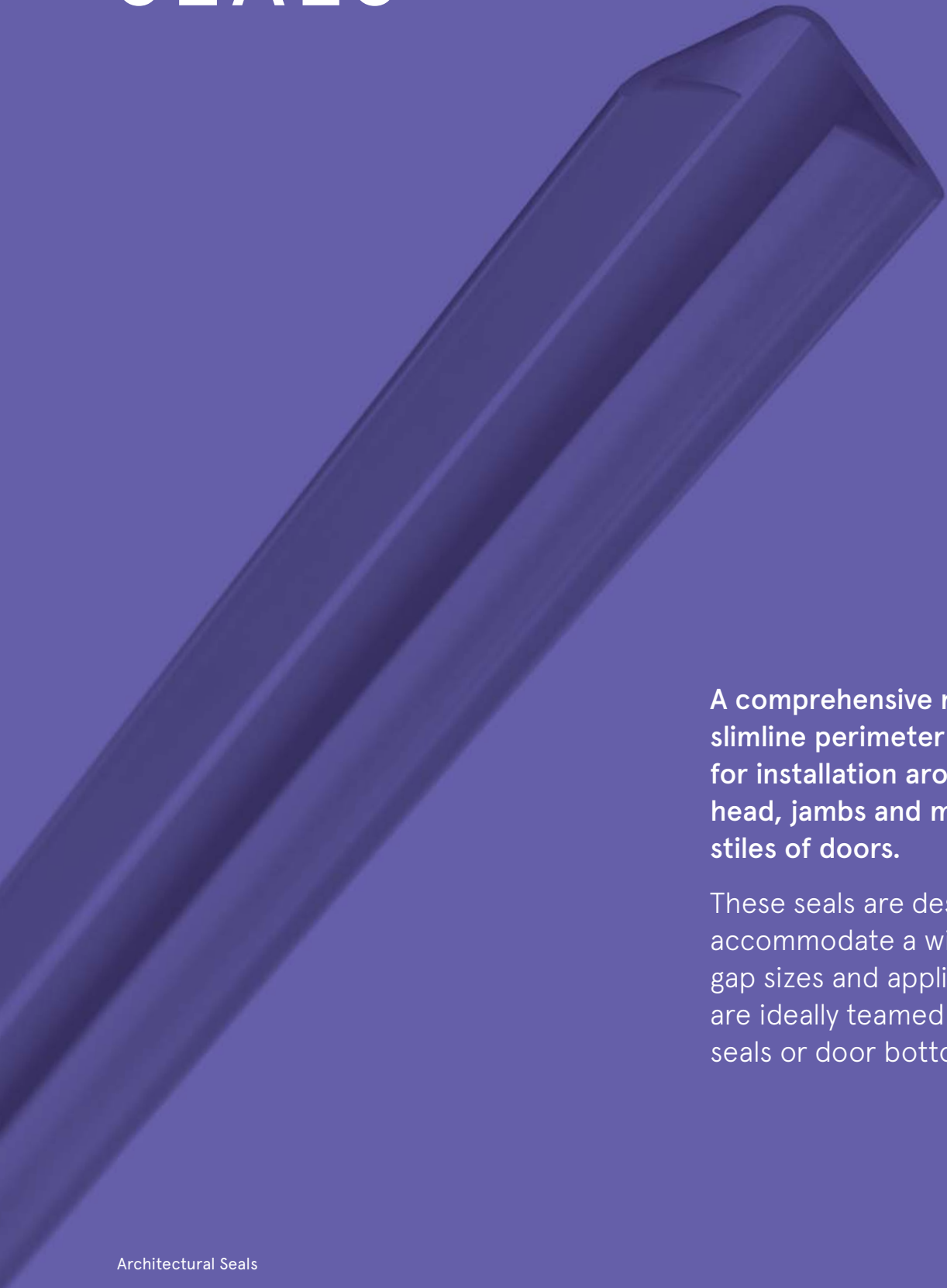

A comprehensive range of slimline perimeter seals for installation around the head, jambs and meeting stiles of doors.

These seals are designed to accommodate a wide range of gap sizes and applications, and are ideally teamed with drop seals or door bottom seals.

LAS1007, LAS1010, LAS1015, LAS1206, LAS1206K, LAS1212 & LAS1212K Batwing®

MEDIUM DUTY **41dB**

A range of popular, medium duty, acoustic and smoke perimeter seals; which minimise the opening and closing resistance of the door leaf due to their unique, curved fins. Flexible elastomeric fin material springs back to original shape to provide ongoing performance and durability in service. They can be fitted with minimal disruption to the door assembly.



PERIMETER SEALS

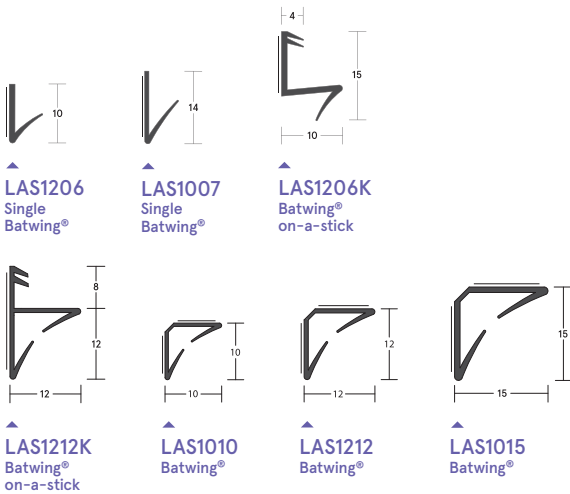

LAS1212 Batwing®

SYSTEM SPECIFICATIONS

Test evidence

- ▶ Acoustic: BS EN ISO 10140-2: 2010 (up to Rw 41dB).
- ▶ Smoke: BS 476-31.1: 1983 at ambient temperature; BS EN 1634-3:2004 at ambient and medium temperature (LAS1212); effective smoke seal up to 200°C.
- ▶ Durability: minimum of 100,000 cycles.

Performance

- ▶ Meets smoke requirement: BS 9999: 2017.
- ▶ Protects against sound, smoke, draught and light.

Location

- ▶ Head and jambs of single and double leaf doors.

Use with

- ▶ Practically any drop seal.

Min/max gap size

- ▶ 3mm/4mm.

Seal material

- ▶ Co-extruded rigid back PVC with flexible fins.

Standard lengths

- ▶ 1m and 2.1m.
- ▶ Single doorset pack consisting of 1 x 1m and 2 x 2.1m.
- ▶ Other lengths to special order.

Fixing

- ▶ Supplied with strong self-adhesive tape, tested on many surfaces, including MDF – suitable for internal use only.

- ▶ Groove size for LAS1212K is 9mm x 3mm – suitable for internal or external use.

Colours

- ▶ Black, white, dark brown, light brown, grey, silver, cream, red and clear.
- ▶ Note: clear Batwing® will not prevent light penetration.

Accreditations



(R27972)



(CF5179)

excludes LAS1206, LAS1007 & LAS1206K



PERIMETER SEALS

LAS1011 & LAS1016 Firtree™

MEDIUM DUTY **40dB**

Highly effective acoustic seals, which also provide additional cold smoke protection around the perimeter of fire rated doors. Flexible and durable. They can be fitted with minimal disruption to the door assembly.

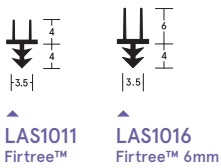

▲ LAS1011 Firtree™

PERIMETER SEALS

SYSTEM SPECIFICATIONS

Test evidence

- ▶ Acoustic: BS EN ISO 10140-2: 2010 (up to Rw 40dB).
- ▶ Smoke: BS 476-31.1: 1983.
- ▶ Durability: minimum of 100,000 cycles.

Performance

- ▶ Meets smoke requirement: BS 9999: 2017.
- ▶ Protects against sound, smoke, draught and light.

Location

- ▶ Head and jambs of single and double leaf doors. May also be used at the threshold when combined with a threshold plate.

Use with

- ▶ Practically any drop seal.

Min/max gap size

- ▶ 3mm/4mm (LAS1011).
- ▶ 4mm/6mm (LAS1016).

Seal material

- ▶ Co-extruded rigid back PVC with flexible fins.

Standard lengths

- ▶ 1m and 2.1m. Other lengths to special order.

Fixing

- ▶ Interference fit into a kerf 3mm wide and minimum 4mm deep.

Colours

- ▶ Black or white.

Accreditations



(R27972)
LAS1011



(CF5179)



LAS7001 si & LAS7002 si

MEDIUM DUTY **33dB** **34dB**

Slimline, aluminium, perimeter seals featuring a silicone gasket ideal for acoustic and smoke containment. Designed to be fitted to existing door stops. A neat cover plate conceals fixing screws. Easily installed without removing the door.



PERIMETER SEALS

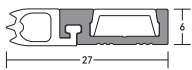

LAS7001 si

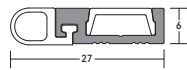

LAS7002 si



LAS7001 si

SYSTEM SPECIFICATIONS

Test evidence

- ▶ Acoustic: BS EN ISO 10140-2: 2010. LAS7001 si Rw 33dB, LAS7002 si Rw 34dB.
- ▶ Smoke: BS EN 1634-3: 2004 (LAS7001 si) & BS 476-31.1: 1983 (LAS7002 si).
- ▶ Durability: minimum of 100,000 cycles.

Performance

- ▶ Meets smoke requirement: BS 9999: 2017.
- ▶ Protects against sound, smoke, weather, draught and light.

Location

- ▶ Head and jambs of single swing doors.

Use with

- ▶ Practically any threshold seal.

Seal material

- ▶ Flexible silicone rubber.

Standard lengths

- ▶ 1m and 2.1m. Single doorset pack consisting of 1 x 1m and 2 x 2.1m. Other lengths to special order.

Fixing

- ▶ Self-tapping wood screws are supplied (self-drilling and self-tapping screws for metal construction available on request).
- ▶ Fixing holes are pre-drilled and slotted to allow the seals to be adjusted and positioned accurately. A PVC cover strip to conceal fixings is supplied.

Finishes

- ▶ Silver anodised aluminium with grey cover strip and grey silicone rubber gasket.
- ▶ Bronze anodised aluminium with black cover strip and black silicone rubber gasket.
- ▶ Black and light bronze anodised aluminium (non-standard - charges and lead times apply).
- ▶ Other powder-coated colour finishes (non-standard - charges and lead times apply).

Accreditation



LAS7003 si

MEDIUM DUTY **33dB**

Slimline, medium duty perimeter seal designed to be compressed between the door and the stop when the door is closed, compensating for warped or unevenly hung doors. Designed to be fitted to existing door stops. A neat cover plate conceals fixing screws. Easily installed without removing the door.

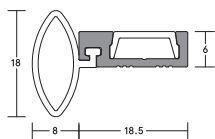

▲ LAS7003 si



PERIMETER SEALS

SYSTEM SPECIFICATIONS

Test evidence

- ▶ Acoustic: BS EN ISO 10140-2: 2010 (up to R_w 33dB).
- ▶ Smoke: BS 476-31.1: 1983.
- ▶ Durability: 1 million cycles.

Performance

- ▶ Meets smoke requirement: BS 9999: 2017.
- ▶ Protects against sound, smoke, weather, draught and light.

Location

- ▶ Head and jambs of single swing doors.

Use with

- ▶ Practically any threshold seal.

Seal material

- ▶ Flexible silicone rubber.

Standard lengths

- ▶ 1m and 2.1m. Single doorset pack consisting of 1 x 1m and 2 x 2.1m. Other lengths to special order.

Fixing

- ▶ Self-tapping wood screws are supplied (self-drilling and self-tapping screws for metal construction available on request)
- ▶ Fixing holes are pre-drilled and slotted to allow the seals to be adjusted and positioned accurately. A PVC cover strip to conceal fixings is supplied.

Finishes

- ▶ Silver anodised aluminium with grey cover strip and grey silicone rubber gasket.
- ▶ Bronze anodised aluminium with black cover strip and black silicone rubber gasket.
- ▶ Black and light bronze anodised aluminium (non-standard - charges and lead times apply).
- ▶ Other powder-coated colour finishes (non-standard - charges and lead times apply).

Accreditation



LAS7004 si

MEDIUM DUTY **34dB**

Slimline, medium duty perimeter seal designed for timber doors with plain or rebated meeting stiles and where a centre latch is required. The leg of this seal can be cut out to accommodate the latch plate. Easily installed without removing the door.



ID No.
163

PERIMETER SEALS

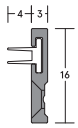

LAS7004 si
4mm

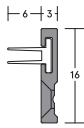

LAS7004 si
6mm



SYSTEM SPECIFICATIONS

Test evidence

- ▶ Acoustic: BS EN ISO 10140-2: 2010 (up to R_w 34dB).
- ▶ Note: two rows of twin elastomeric fins will provide optimum acoustic performance.

Performance

- ▶ Protects against sound, smoke, weather, draught and light.

Location

- ▶ Meeting stiles of single and double swing doors.
- ▶ Sliding and revolving doors.

Use with

- ▶ Practically any threshold seal.

Seal material

- ▶ Choose from: (i) 4mm projection twin elastomeric fins (ii) 6mm projection twin elastomeric fins.

Standard lengths

- ▶ 1m and 2.1m. Other lengths to special order.

Fixing

- ▶ Wood screws are supplied (self-tapping screws for metal frames are available on request).
- ▶ Fixing holes are predrilled and countersunk.

Finishes

- ▶ Silver anodised aluminium with grey twin seal insert.
- ▶ Bronze anodised aluminium with black twin seal insert.
- ▶ Black and light bronze anodised aluminium (non-standard - charges and lead times apply).
- ▶ Other powder-coated colour finishes (non-standard - charges and lead times apply).

LAS7005 si

MEDIUM DUTY **31dB**

A neat, aesthetically designed, compact perimeter seal with proven effective acoustic performance. Decorative cover strip conceals fixings. This seal can be used to replace the stop on steel or timber framed doors. To avoid excessive impact on the seal we recommend using a door closer to aid closing control.

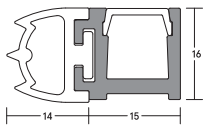

▲ LAS7005 si



PERIMETER SEALS

SYSTEM SPECIFICATIONS

Test evidence

- ▶ Acoustic: BS EN ISO 10140-2: 2010 (up to Rw 31dB).

Performance

- ▶ Protects against sound, smoke, weather, draught and light.

Location

- ▶ Head and jambs of single swing doors.

Use with

- ▶ Practically any threshold seal.

Seal material

- ▶ Flexible silicone rubber.

Standard lengths

- ▶ 1m and 2.1m. Single doorset pack consisting of 1 x 1m and 2 x 2.1m.
- ▶ Other lengths to special order.

Fixing

- ▶ Self-tapping wood screws are supplied (self-drilling and self-tapping screws for metal construction available on request)
- ▶ Fixing holes are pre-drilled and slotted to allow the seals to be adjusted and positioned accurately. A PVC cover strip to conceal fixings is supplied.

Finishes

- ▶ Silver anodised aluminium with grey cover strip and grey silicone rubber gasket.
- ▶ Bronze anodised aluminium with black cover strip and black silicone rubber gasket.
- ▶ Black and light bronze anodised aluminium (non-standard - charges and lead times apply).
- ▶ Other powder-coated colour finishes (non-standard - charges and lead times apply).

PERIMETER SEALS

LAS7030 si & LAS7040 si

MEDIUM DUTY / HEAVY DUTY

A medium duty (LAS7030 si) and a heavy duty (LAS7040 si), slimline perimeter seal with a durable grade 304 stainless steel fixing plate. Provides acoustic and smoke containment when fitted with a suitable threshold seal.



PERIMETER SEALS

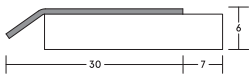

▲ LAS7030 si

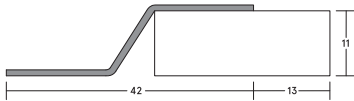

▲ LAS7040 si



▲ LAS7030 si

SYSTEM SPECIFICATIONS

Performance

- ▶ Protects against sound, smoke, weather, draught and light when fitted with a suitable threshold seal.

Location

- ▶ Head and jambs of single swing doors.
- ▶ Heavy duty hinged doors (LAS7040 si).

Use with

- ▶ Practically any threshold seal.

Seal material

- ▶ Foamed silicone rubber.

Standard lengths

- ▶ 1m and 2.1m. Other lengths to special order.

Fixing

- ▶ Stainless steel fixing screws are supplied.
- ▶ Fixing holes are pre-drilled and slotted to allow the seals to be adjusted and positioned accurately.

Finishes

- ▶ Brushed stainless steel with grey silicone rubber insert.
- ▶ Polished stainless steel (non-standard - charges and lead times apply).

LAS7050

MEDIUM DUTY

A translucent perimeter seal with a rigid element integrating an elastomer bulb. Suitable for glass door edges - hinged doors into timber or aluminium frames. This virtually clear product perfectly complements the natural features of a glass door, without compromising on aesthetics.

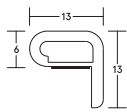

^
LAS7050



PERIMETER SEALS

SYSTEM SPECIFICATIONS

Performance

- ▶ Protects against draught, weather and insects.
- ▶ Suitable for various glass thicknesses from 8mm.

Location

- ▶ Single swing doors.

Seal material

- ▶ Clear/translucent elastomer.

Standard lengths

- ▶ 1m and 2.1m. Other lengths to special order.

Fixing

- ▶ Fitted using strong adhesive tape.

Finish

- ▶ Translucent.

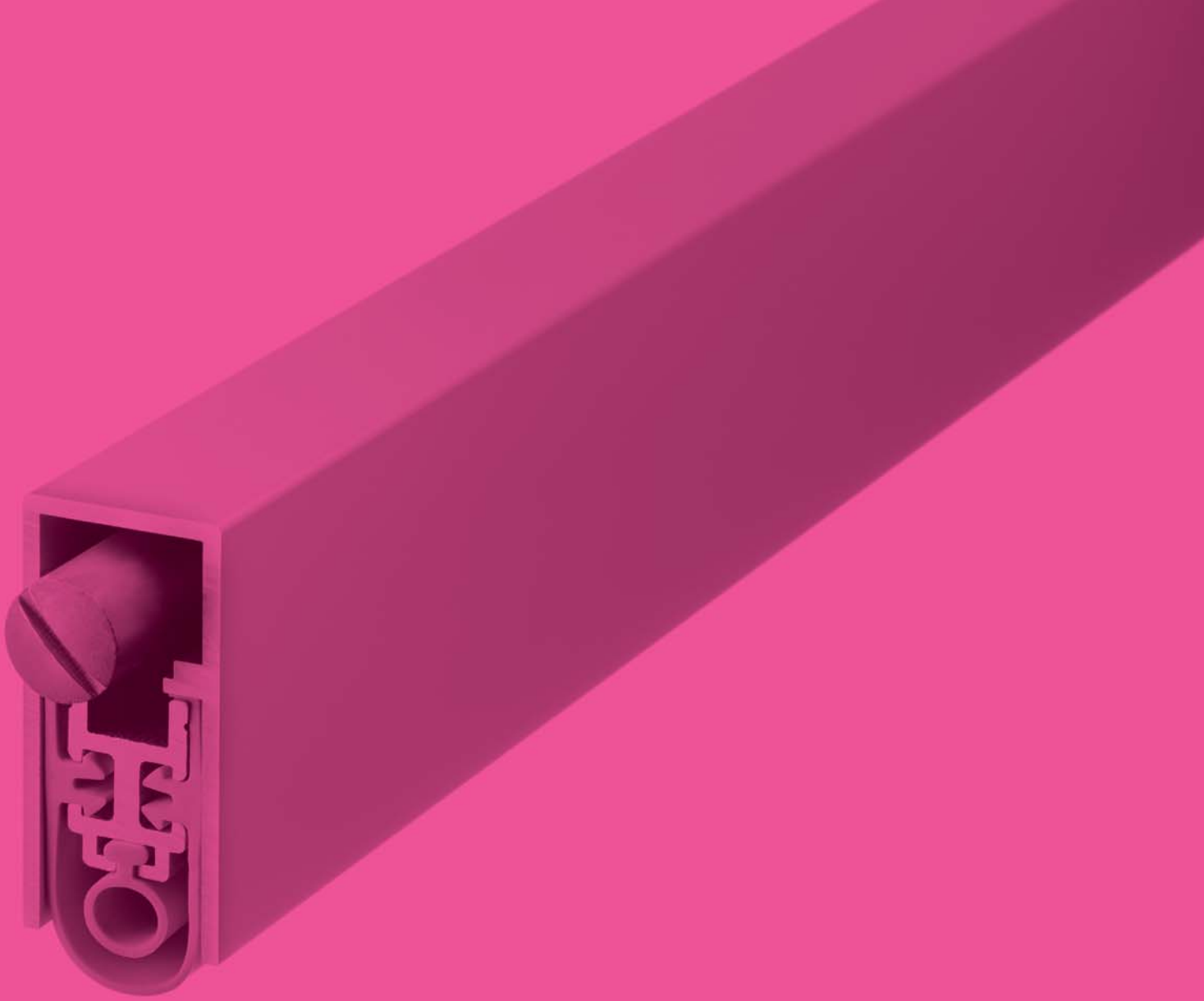

DROP SEALS

A range of drop seals that fit to the bottom of a door and drop down automatically when the door closes to form a firm seal. Options include face-fixed installation, and semi or fully mortising into door leaves, for both medium and heavy duty applications.

A spring-loaded mechanism, requiring no power, ensures easy door operation and effective sealing when closed.

DROP SEALS

LAS8001 si

HEAVY DUTY **39dB**

A slimline, mortised automatic drop seal. It features a high efficiency mechanism, which lifts the seal clear of the floor as soon as the door is opened by a few millimetres; resulting in lower door operating forces. Requires no power connection. Self-levelling on uneven floors; seal height can be adjusted independently of fixing screws.

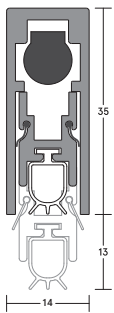

LAS8001 si



LAS8001 si (shown with LAS4001)

DROP SEALS

SYSTEM SPECIFICATIONS

Test evidence

- ▶ Acoustic: BS EN ISO 10140-2: 2010 (up to Rw 39dB).
- ▶ Smoke: BS EN 1634-3: 2004 & BS 476-31.1: 1983.
- ▶ Fire: BS 476: Pt.20/22: 1987 & BS EN 1634-1: 2014.
- ▶ Durability: 1 million cycles.

Performance

- ▶ Meets smoke requirement: BS 9999: 2017.
- ▶ Protects against sound, smoke, fire, draught, light and insects.
- ▶ Suitable for wheeled traffic.

Location

- ▶ Single swing, single and double leaf doors. For use on both right and left handed doors.

Use with

- ▶ Any perimeter seal. Any threshold plate.

Min/max gap size

- ▶ 1mm/13mm.

Seal material

- ▶ Grey or black silicone rubber.

Standard lengths

- ▶ 335mm, 435mm, 535mm, 635mm, 735mm, 835mm, 935mm, 1035mm, 1135mm and 1235mm. Sizes above 1235mm are available on request.
- ▶ Note: Each length can be cut back to the next size down. The 335mm can be cut back to 255mm.

Fixing

- ▶ Fixing screws are supplied. This seal is mortised. Pre-drilled radiused end plates

are supplied which also secure the product in place. (Square end plates available on request).

Adjustment

- ▶ Self-levelling on uneven surfaces.

Finishes

- ▶ Silver anodised aluminium with silver end plates, and grey silicone rubber gasket.
- ▶ Silver anodised aluminium with bronze end plates, and black silicone rubber gasket.

Accreditations



(R27972)



(CF5179)



DROP SEALS

LAS8001M

HEAVY DUTY

A slimline, mortised automatic drop seal for timber sliding doors. The end plate cleverly conceals a magnet which engages with a button in the frame, to assist the door closure and ensures the gasket remains in the dropped position without forcing the door open. The seal features a high efficiency mechanism, which lifts the seal clear of the floor as soon as the door is opened by a few millimetres; resulting in lower door operating forces.



DROP SEALS

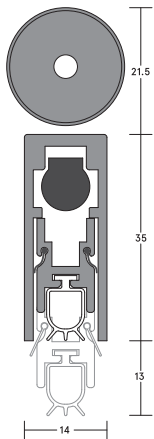

LAS8001M

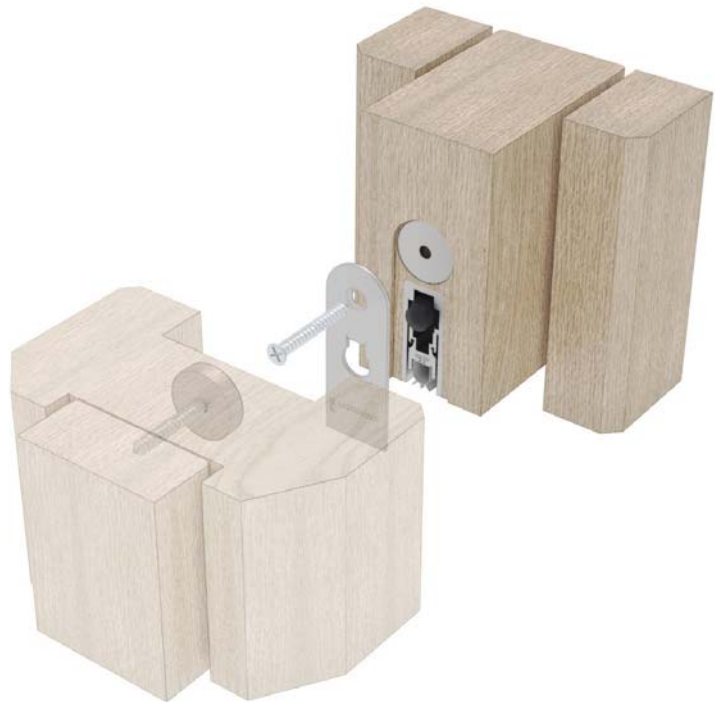

SYSTEM SPECIFICATIONS

Performance

- ▶ Protects against sound, smoke, draught, light and insects.
- ▶ Suitable for wheeled traffic.

Location

- ▶ Sliding doors.

Use with

- ▶ Any perimeter seal. Any threshold plate.

Min/max gap size

- ▶ 1mm/13mm.

Seal material

- ▶ Grey or black silicone rubber.

Standard lengths

- ▶ 335mm, 435mm, 535mm, 635mm, 735mm, 835mm, 935mm, 1035mm, 1135mm and 1235mm. Sizes above 1235mm are available on request.
- ▶ Note: Each length can be cut back to the next size down. The 335mm can be cut back to 255mm.

Fixing

- ▶ Fixing screws are supplied. This seal is mortised. Pre-drilled radiused end plates are supplied which also secure the product in place. (Square end plates available on request).
- ▶ Magnetised button is supplied to fix into the frame.

Adjustment

- ▶ Self-levelling on uneven surfaces. Can be adjusted independently of the fixing screws.

Finishes

- ▶ Silver anodised aluminium with silver end plates, and grey silicone rubber gasket.
- ▶ Silver anodised aluminium with bronze end plates, and black silicone rubber gasket.
- ▶ Chrome finish magnetised button.

DROP SEALS

LAS8002 si

MEDIUM DUTY **31dB**

A slimline face-fixed or semi-mortised automatic drop seal. It features a high efficiency mechanism, which lifts the seal clear of the floor as soon as the door is opened by a few millimetres; resulting in lower door operating forces. Surface mounted application suitable for upgrading existing doors. Requires no power connection. Self-levelling on uneven floors; seal height can be adjusted independently of fixing screws.

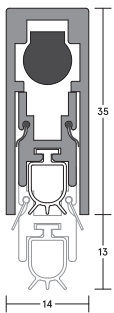

▲ LAS8002 si



▲ LAS8002 si (shown with LAS4001)

DROP SEALS

SYSTEM SPECIFICATIONS

Test evidence

- ▶ Acoustic: BS EN ISO 10140-2: 2010 (up to Rw 31dB).
- ▶ Smoke: BS EN 1634-3: 2004 & BS 476-31.1: 1983.

Performance

- ▶ Meets smoke requirement: BS 9999: 2017.
- ▶ Suitable for use on timber fire doors.
- ▶ Protects against sound, smoke, fire, draught, light and insects. Suitable for wheeled traffic.

Location

- ▶ Single swing, single and double leaf doors.
- ▶ For use on both right and left handed doors.

Use with

- ▶ Any perimeter seal. Any threshold plate.

Min/max gap size

- ▶ 1mm/13mm.

Seal material

- ▶ Grey silicone rubber.

Standard lengths

- ▶ 335mm, 435mm, 535mm, 635mm, 735mm, 835mm, 935mm, 1035mm, 1135mm and 1235mm.
- ▶ Note: Each length can be cut back to the next size down. The 335mm can be cut back to 255mm.

Fixing

- ▶ LAS8002 si is face-fixed or semi-mortised onto the door bottom.
- ▶ Screw fix using screws and ferrules provided. Fit end caps.

Adjustment

- ▶ Self-levelling on uneven surfaces.
- ▶ Can be adjusted independently of the fixing screws.

Finishes

- ▶ Silver anodised aluminium with grey end caps and grey silicone rubber gasket.
- ▶ Bronze anodised aluminium with black end caps and black silicone rubber gasket.
- ▶ Please see page 69 for further finishes info.

Accreditations



DROP SEALS

LAS8002G si

MEDIUM DUTY

A slimline face-fixed drop seal suitable for glass doors – hinged into timber or aluminium frames. A smooth back plate creates a visual aesthetic. LAS8002G si features a high efficiency mechanism, which lifts the seal clear of the floor as soon as the door is opened by a few millimetres; resulting in lower door operating forces.



DROP SEALS

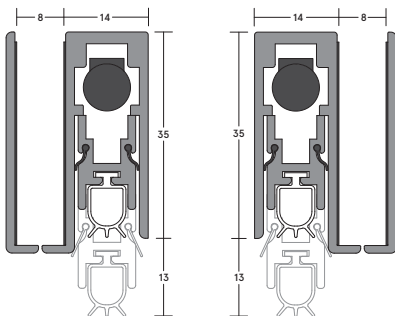

▲ LAS8002G si (right handed)

▲ LAS8002G si (left handed)

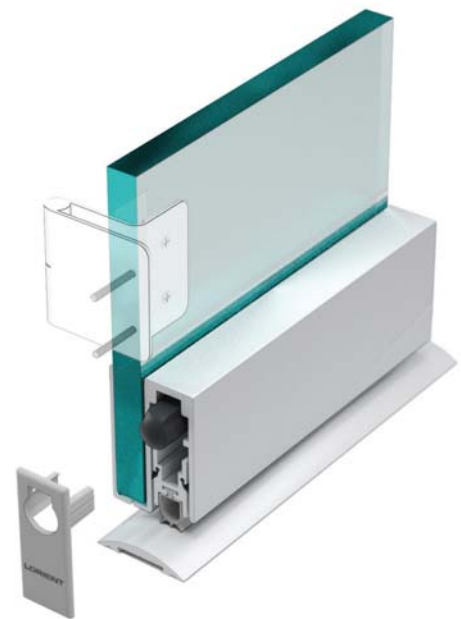

▲ LAS8002G si (shown with LAS4001)

SYSTEM SPECIFICATIONS

Test evidence

- ▶ Durability: 1 million cycles.

Performance

- ▶ Meets smoke requirement: BS 9999: 2017.
- ▶ Protects against smoke, draught and insects.
- ▶ Suitable for wheeled traffic.

Location

- ▶ Single swing doors.
- ▶ For use on both right and left handed doors.

Use with

- ▶ Any perimeter seal. Any threshold plate.

Min/max gap size

- ▶ 1mm/10mm.

Seal material

- ▶ Grey silicone rubber.

Standard lengths

- ▶ 335mm, 435mm, 535mm, 635mm, 735mm, 835mm, 935mm, 1035mm, 1135mm and 1235mm.
- ▶ Note: Each length can be cut back to the next size down. The 335mm can be cut back to 255mm.

Fixing

- ▶ LAS8002G si carrier and back plate are face-fixed with strong adhesive tape.
- ▶ Fit end caps.
- ▶ This product is non-reversible and needs to be ordered left or right handed.

Adjustment

- ▶ Self-levelling on uneven surfaces.

Finishes

- ▶ Silver anodised aluminium with grey end caps and grey silicone rubber gasket.
- ▶ Bronze anodised aluminium with black end caps and black silicone rubber gasket.
- ▶ Black and light bronze anodised aluminium (non-standard – charges and lead times apply).
- ▶ Other powder-coated colour finishes (non-standard – charges and lead times apply).

DROP SEALS

LAS8003 si

MEDIUM DUTY **33dB**

A slimline face-fixed or semi-mortised automatic drop seal. It features a high efficiency mechanism, which lifts the seal clear of the floor as soon as the door is opened by a few millimetres; resulting in lower door operating forces. Surface mounted application suitable for upgrading existing doors. Requires no power connection. Self-levelling on uneven floors; seal height can be adjusted independently of fixing screws.

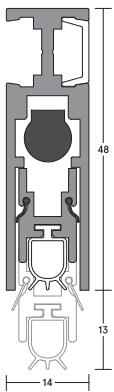

▲ LAS8003 si

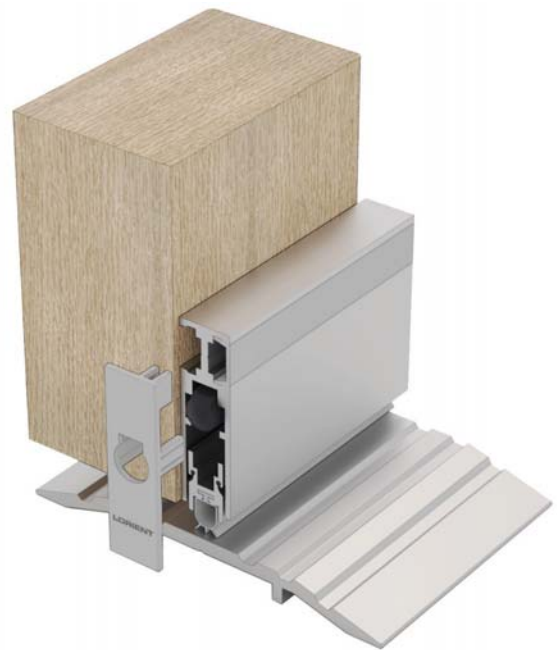

▲ LAS8003 si (shown with LAS4100)

DROP SEALS

SYSTEM SPECIFICATIONS

Test evidence

- ▶ Acoustic: BS EN ISO 10140-2: 2010 (up to Rw 33dB).
- ▶ Smoke: BS EN 1634-3: 2004 & BS 476-31.1:1983.

Performance

- ▶ Meets smoke requirement: BS 9999: 2017.
- ▶ Suitable for use on timber fire doors.
- ▶ Protects against sound, smoke, fire, draught, light and insects. Suitable for wheeled traffic.

Location

- ▶ Single swing, single and double leaf doors.
- ▶ For use on both right and left handed doors.

Use with

- ▶ Any perimeter seal. Any threshold plate.

Min/max gap size

- ▶ 1mm/13mm.

Seal material

- ▶ Grey silicone rubber.

Standard lengths

- ▶ 335mm, 435mm, 535mm, 635mm, 735mm, 835mm, 935mm, 1035mm, 1135mm and 1235mm.
- ▶ Note: Each length can be cut back to the next size down. The 335mm can be cut back to 255mm.

Fixing

- ▶ LAS8003 si is face-fixed or semi-mortised onto the door bottom.
- ▶ Fixing screws are provided.

Adjustment

- ▶ Self-levelling on uneven surfaces.
- ▶ Can be adjusted independently of the fixing screws.

Finishes

- ▶ Silver anodised aluminium with grey end caps and grey silicone rubber gasket.
- ▶ Bronze anodised aluminium with black end caps and black silicone rubber gasket.
- ▶ Please see page 69 for further finishes info.

Accreditations



DROP SEALS

LAS8004 si

HEAVY DUTY

A heavy duty, mortised, automatic 'flat back' drop seal to suit installation to metal door rails. It features a high efficiency mechanism, which lifts the seal clear of the floor as soon as the door is opened by a few millimetres; resulting in lower door operating forces. Requires no power connection. Self-levelling on uneven floors; seal height can be adjusted independently of fixing screws.



DROP SEALS

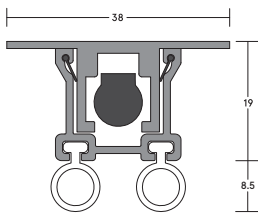

LAS8004 si

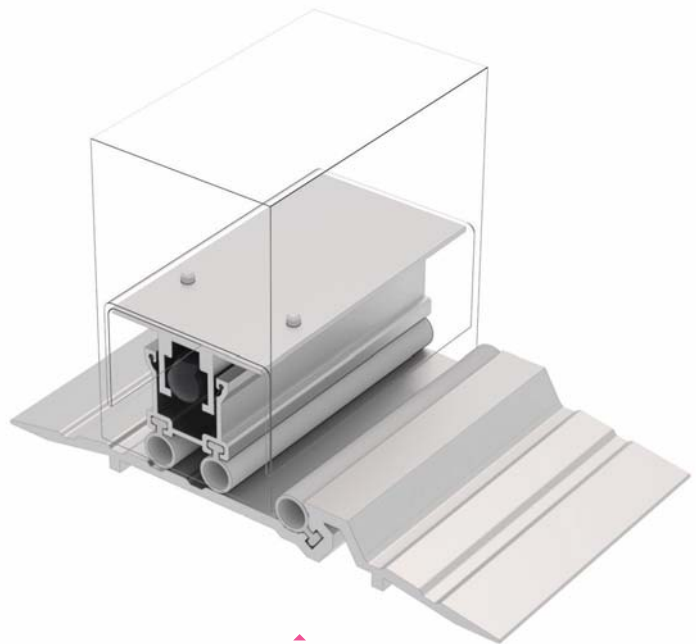

LAS8004 si
(shown with LAS4014 si)

SYSTEM SPECIFICATIONS

Performance

- ▶ Meets smoke requirement: BS 9999: 2017.
- ▶ Protects against smoke, draught, light and insects.
- ▶ Suitable for wheeled traffic.

Location

- ▶ Single swing, single and double leaf doors.
- ▶ Can be used on either right or left handed doors.

Use with

- ▶ Any threshold plate.

Min/max gap size

- ▶ 1mm/13mm.

Seal material

- ▶ Grey silicone gasket.

Standard lengths

- ▶ 635mm, 735mm, 835mm, 935mm, 1035mm, 1135mm and 1235mm.
- ▶ Note: Each length can be cut back to the next size down. The 635mm can be cut back to 535mm. Other lengths to special order.

Fixing

- ▶ Fixing screws are supplied, fixing holes are pre-drilled.

Adjustment

- ▶ Self-levelling on uneven surfaces.

Finish

- ▶ Silver anodised aluminium.

Accreditation



DROP SEALS

LAS8005 si

HEAVY DUTY **33dB**

A slimline, mortised automatic drop seal. It features a high efficiency mechanism, which lifts the seal clear of the floor as soon as the door is opened by a few millimetres; resulting in lower door operating forces. Requires no power connection. Self-levelling on uneven floors; seal height can be adjusted independently of fixing screws. Can be fitted to aluminium doors by door fabricators.

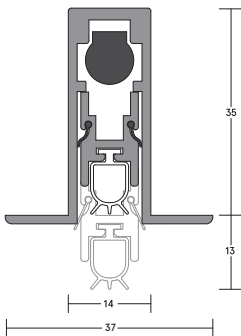

▲ LAS8005 si



ID No. 270

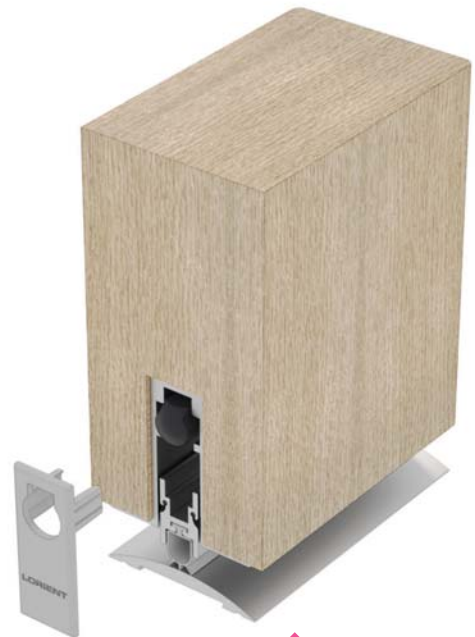

▲ LAS8005 si (shown with LAS4002)

DROP SEALS

SYSTEM SPECIFICATIONS

Test evidence

- ▶ Acoustic: BS EN ISO 10140-2: 2010 (up to Rw 33dB).
- ▶ Smoke: BS EN 1634-3: 2004 & BS 476-31.1: 1983.
- ▶ Fire: BS 476: Pt.20/22: 1987 & BS EN 1634-1: 2014.
- ▶ Durability: 1 million cycles.

Performance

- ▶ Meets smoke requirement: BS 9999: 2017.
- ▶ Protects against sound, smoke, fire, draught, light and insects.
- ▶ Suitable for wheeled traffic.

Location

- ▶ Single swing, single and double leaf doors.
- ▶ For use on both right and left handed doors.

Use with

- ▶ Any perimeter seal. Any threshold plate.

Min/max gap size

- ▶ 1mm/13mm.

Seal material

- ▶ Grey silicone rubber.

Lengths

- ▶ 335mm, 435mm, 535mm, 635mm, 735mm, 835mm, 935mm, 1035mm, 1135mm and 1235mm.
- ▶ Note: Each length can be cut back to the next size down. 335mm can be cut back to 255mm.

Fixing

- ▶ This seal is mortised, and screw fixed via the flanges.

- ▶ Fixing screws are supplied; fixing holes are pre-drilled and countersunk.

Adjustment

- ▶ Self-levelling on uneven surfaces. Seal height can be adjusted independently of the fixing screws.

Finishes

- ▶ Silver anodised aluminium, with grey end caps and grey silicone rubber.
- ▶ Silver anodised aluminium, with black end caps and black silicone rubber.

Accreditations



(R27972)



DROP SEALS

LAS8006 si

HEAVY DUTY **30dB**

A heavy duty, face-fixed or semi-mortised automatic drop seal. It features a high efficiency mechanism, which lifts the seal clear of the floor as soon as the door is opened by a few millimetres; resulting in lower door operating forces. Requires no power connection. Self-levelling on uneven floors; seal height can be adjusted independently of fixing screws.



DROP SEALS

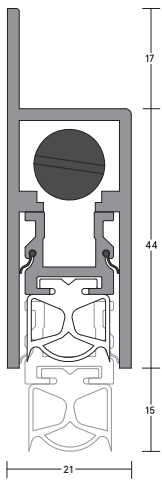

LAS8006 si

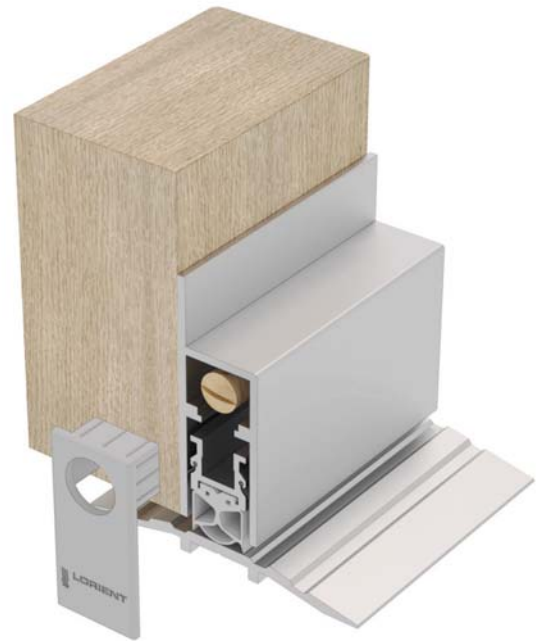

LAS8006 si (shown with LAS4010)

SYSTEM SPECIFICATIONS

Test evidence

- ▶ Acoustic: BS EN ISO 10140-2: 2010 (up to R_w 30dB).
- ▶ Smoke: BS 476-31.1: 1983.
- ▶ Durability: 1 million cycles.

Performance

- ▶ Meets smoke requirement: BS 9999: 2017.
- ▶ Suitable for use on timber fire doors.
- ▶ Protects against sound, smoke, fire, draught, light and insects.
- ▶ Suitable for wheeled traffic.

Location

- ▶ Single swing, single and double leaf doors.
- ▶ For use on both right and left handed doors.

Use with

- ▶ Any perimeter seal. Any threshold plate.

Min/max gap size

- ▶ 1mm/15mm.

Seal material

- ▶ Black or grey silicone rubber.

Standard lengths

- ▶ 335mm, 435mm, 535mm, 635mm, 735mm, 835mm, 935mm, 1035mm, 1135mm and 1235mm.
- ▶ Note: Each length can be cut back to the next size down. The 335mm can be cut back to 275mm.

Fixing

- ▶ Fixing screws are supplied, holes should be drilled at time of fixing.

Adjustment

- ▶ Self-levelling on uneven surfaces – can be adjusted independently of the fixing screws.

Finishes

- ▶ Silver anodised aluminium with grey end caps and grey silicone rubber gasket.
- ▶ Bronze anodised aluminium with black end caps and black silicone rubber gasket.
- ▶ Black and light bronze anodised aluminium (non-standard – charges and lead times apply).
- ▶ Other powder-coated colour finishes (non-standard – charges and lead times apply).

Accreditation



(R27972)

LORIENT

DROP SEALS

LAS8007 si

HEAVY DUTY **39dB**

A heavy duty mortised automatic drop seal. It features a high efficiency mechanism, which lifts the seal clear of the floor as soon as the door is opened by a few millimetres; resulting in lower door operating forces. Requires no power connection. Self-levelling on uneven floors; seal height can be adjusted independently of fixing screws. This is a fully-mortised version of LAS8006 si.

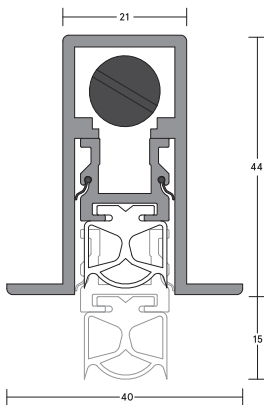

LAS8007 si



LAS8007 si (shown with LAS4011)

DROP SEALS

SYSTEM SPECIFICATIONS

Test evidence

- ▶ Acoustic: BS EN ISO 10140-1: 2010+A2: 2014 (Annex J) up to Rw 39dB.
- ▶ Smoke: BS 476-31.1: 1983.
- ▶ Durability: 1 million cycles.

Performance

- ▶ Meets smoke requirement: BS 9999: 2017.
- ▶ Protects against sound, smoke, draught, light and insects.
- ▶ Suitable for wheeled traffic.

Location

- ▶ Single swing, single and double leaf doors.
- ▶ For use on both right and left handed doors.

Use with

- ▶ Any perimeter seal. Any threshold plate.

Min/max gap size

- ▶ 1mm/15mm.

Seal material

- ▶ Black or grey silicone rubber.

Standard lengths

- ▶ 335mm, 435mm, 535mm, 635mm, 735mm, 835mm, 935mm, 1035mm, 1135mm and 1235mm.
- ▶ Note: Each length can be cut back to the next size down. The 335mm can be cut back to 275mm.

Fixing

- ▶ Fixing screws and end caps are supplied.

- ▶ Fixing holes are pre-drilled through the flanges.

Adjustment

- ▶ Self-levelling on uneven surfaces - can be adjusted independently of the fixing screws.

Finishes

- ▶ Silver anodised aluminium, with grey end caps and grey silicone rubber.
- ▶ Silver anodised aluminium, with black end caps and black silicone rubber.

Accreditation



(R27972)

DROP SEALS

LAS8008 si

MEDIUM DUTY **30dB**

A slimline face-fixed automatic drop seal with a curved cover plate for enhanced aesthetics. It features a high efficiency mechanism, which lifts the seal clear of the floor as soon as the door is opened by a few millimetres; resulting in lower door operating forces. Requires no power connection. Self-levelling on uneven floors, seal height can be adjusted independently of fixing screws. Suitable for upgrading existing doors.



DROP SEALS

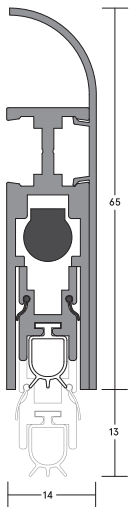

LAS8008 si

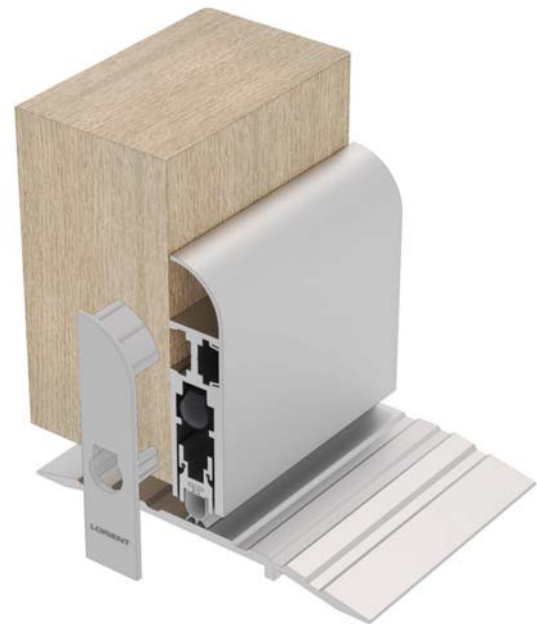

LAS8008 si (shown with LAS4011)

SYSTEM SPECIFICATIONS

Test evidence

- ▶ Acoustic: BS EN ISO 10140-2: 2010 (up to Rw 30dB).
- ▶ Smoke: BS 476-31.1: 1983.

Performance

- ▶ Meets smoke requirement: BS 9999: 2017.
- ▶ Suitable for use on timber fire doors.
- ▶ Protects against sound, smoke, fire, draught, light and insects.
- ▶ Suitable for wheeled traffic.

Location

- ▶ Single swing, single and double leaf doors.
- ▶ For use on both right and left handed doors.

Use with

- ▶ Any perimeter seal. Any threshold plate.

Min/max gap size

- ▶ 1mm/13mm.

Seal material

- ▶ Grey silicone rubber.

Standard lengths

- ▶ 335mm, 435mm, 535mm, 635mm, 735mm, 835mm, 935mm, 1035mm, 1135mm and 1235mm.
- ▶ Note: Each length can be cut back to the next size down. The 335mm can be cut back to 255mm.

Fixing

- ▶ Fixing screws are supplied, holes should be drilled at time of fixing. LAS8008 si is face-fixed only.

Adjustment

- ▶ Self-levelling on uneven surfaces.
- ▶ Can be adjusted independently of the fixing screws.

Finishes

- ▶ Silver anodised aluminium cover plate with grey end caps and grey silicone rubber gasket.
- ▶ Bronze anodised aluminium cover plate black end caps and black silicone rubber gasket.
- ▶ Black and light bronze anodised aluminium (non-standard - charges and lead times apply).
- ▶ Other powder-coated colour finishes (non-standard - charges and lead times apply).

DROP SEALS

LAS8009 si

HEAVY DUTY **31dB**

A heavy duty face-fixed automatic drop seal with curved cover plate that conceals fixing screws and presents an exceptionally smooth external aspect. It features a high efficiency mechanism, which lifts the seal clear of the floor as soon as the door is opened by a few millimetres; resulting in lower door operating forces. Requires no power connection. Self-levelling on uneven floors; seal height can be adjusted independently of fixing screws.

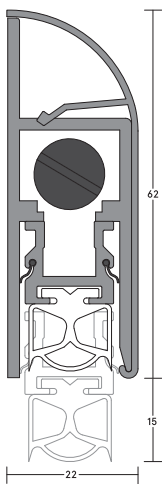

LAS8009 si



LAS8009 si (shown with LAS4055)

DROP SEALS

SYSTEM SPECIFICATIONS

Test evidence

- ▶ Acoustic: BS EN ISO 10140-2: 2010 (up to Rw 31dB).
- ▶ Smoke: BS EN 1634-3: 2004.

Performance

- ▶ Meets smoke requirement: BS 9999: 2017.
- ▶ Suitable for use on timber fire doors.
- ▶ Protects against sound, smoke, fire, draught, light and insects.
- ▶ Suitable for wheeled traffic.

Location

- ▶ Single swing, single and double leaf doors.
- ▶ For use on both right and left handed doors.

Use with

- ▶ Any perimeter seal. Any threshold plate.

Min/max gap size

- ▶ 1mm/15mm.

Seal material

- ▶ Black or grey silicone rubber.

Standard lengths

- ▶ 335mm, 435mm, 535mm, 635mm, 735mm, 835mm, 935mm, 1035mm, 1135mm and 1235mm.
- ▶ Note: Each length can be cut back to the next size down. The 335mm can be cut back to 275mm.

Fixing

- ▶ Fixing screws are supplied, holes should be drilled at time of fixing. End caps are supplied.

Adjustment

- ▶ Self-levelling on uneven surfaces – can be adjusted independently of the fixing screws.

Finishes

- ▶ Silver anodised aluminium cover plate with grey end caps and grey silicone rubber gasket.
- ▶ Bronze anodised aluminium cover plate with black end caps and black silicone rubber gasket.
- ▶ Please see page 69 for further finishes info.

Accreditation



(R27972)

DROP SEALS

LAS8012 si

HEAVY DUTY 43dB

A heavy duty automatic drop seal designed for optimum acoustic performance. Requires no power connection. Self-levelling on uneven floors; seal height can be adjusted independently of fixing screws. Supplied with standard nylon end caps. Die cast end plates in a metallic finish for premium aesthetics are an option.



DROP SEALS

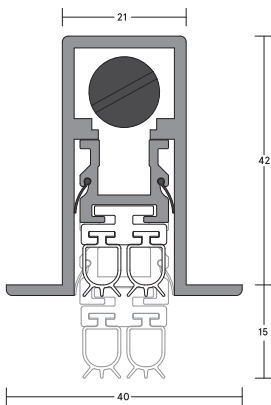

LAS8012 si



LAS8012 si (shown with LAS4002)

SYSTEM SPECIFICATIONS

Test evidence

- ▶ Acoustic: BS EN ISO 10140-1: 2010+A2: 2014 (Annex J) up to Rw 43dB.

Performance

- ▶ Meets smoke requirement: BS 9999: 2017.
- ▶ Protects against sound, smoke, draught, light and insects.
- ▶ Suitable for wheeled traffic.

Location

- ▶ Single swing, single and double leaf doors.
- ▶ For use on both right and left handed doors.

Use with

- ▶ Any perimeter seal. Any threshold plate.

Min/max gap size

- ▶ 1mm/15mm.

Seal material

- ▶ Black or grey silicone rubber.

Standard lengths

- ▶ 335mm, 435mm, 535mm, 635mm, 735mm, 835mm, 935mm, 1035mm, 1135mm and 1235mm.
- ▶ Note: Each length can be cut back to the next size down. The 335mm can be cut back to 275mm.

Fixing

- ▶ Fixing screws are supplied, fixing holes are pre-drilled through the flanges.

Adjustment

- ▶ Self-levelling on uneven surfaces - can be adjusted independently of the fixing screws.

Finishes

- ▶ Silver anodised aluminium with grey end caps and grey silicone rubber gasket.
- ▶ Silver anodised aluminium with black end caps and black silicone rubber gasket.
- ▶ Die cast end plates in square and radiused versions are also available in a metallic finish.
- ▶ The non-button end cap is designed blank, creating an engineered smooth aesthetic.

DROP SEALS

LAS8013 si

HEAVY DUTY **43dB**

A heavy duty automatic drop seal designed for optimum performance. It requires no power connection. Self-levelling on uneven floors; seal height can be adjusted independently of fixing screws. Supplied with standard nylon end caps. Die cast end plates in a metallic finish for premium aesthetics are an option.

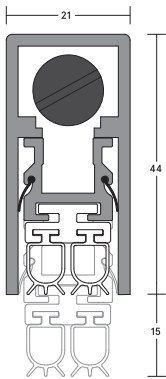

LAS8013 si



LAS8013 si (shown with LAS4002)

DROP SEALS

SYSTEM SPECIFICATIONS

Test evidence

- ▶ Acoustic: BS EN ISO 10140-1: 2010+A2: 2014 (Annex J) up to Rw 43dB.

Performance

- ▶ Meets smoke requirement: BS 9999: 2017.
- ▶ Protects against sound, smoke, draught, light and insects.
- ▶ Suitable for wheeled traffic.

Location

- ▶ Single swing, single and double leaf doors.
- ▶ For use on both right and left handed doors.

Use with

- ▶ Any perimeter seal. Any threshold plate.

Min/max gap size

- ▶ 1mm/15mm.

Seal material

- ▶ Black or grey silicone rubber.

Standard lengths

- ▶ 335mm, 435mm, 535mm, 635mm, 735mm, 835mm, 935mm, 1035mm, 1135mm and 1235mm.
- ▶ Note: Each length can be cut back to the next size down. The 335mm can be cut back to 275mm.

Fixing

- ▶ This seal is mortised. Pre-drilled end plates are supplied which also secure the product in place. Fixing screws are supplied.

- ▶ Both square and radiused end plates are available.

Adjustment

- ▶ Self-levelling on uneven surfaces - can be adjusted independently of the fixing screws.

Finishes

- ▶ Silver anodised aluminium, grey silicone rubber gasket.
- ▶ Silver anodised aluminium, black silicone rubber gasket.
- ▶ Die cast end plates in square and radiused versions are available in a metallic finish.
- ▶ The non-button end cap is designed blank, creating an engineered smooth aesthetic.

DROP SEALS

LAS8014 si

HEAVY DUTY 47dB

A durable, heavy duty automatic drop seal featuring a wrap-around outer gasket with an additional internal gasket designed for superior acoustic performance. The seal features a parallel drop mechanism. It is spring-loaded to lift clear of the floor as soon as the door is opened by a few millimetres. Die cast end plates are available in a metallic finish for premium aesthetics.



DROP SEALS

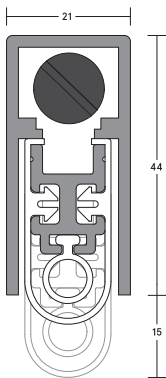

LAS8014 si



LAS8014 si (shown with LAS4002)

SYSTEM SPECIFICATIONS

Test evidence

- ▶ Acoustic: BS EN ISO 10140-1: 2010+A2: 2014 (Annex J) up to Rw 47dB.
- ▶ Durability: 1 million cycles.

Performance

- ▶ Meets smoke requirement: BS 9999: 2017.
- ▶ Protects against sound, smoke, draught, light and insects.
- ▶ Suitable for wheeled traffic.
- ▶ Parallel drop mechanism.

Location

- ▶ Single swing, single and double leaf doors.
- ▶ For use on both right and left handed doors.

Use with

- ▶ Any perimeter seal. Any threshold plate.

Min/max gap size

- ▶ 6mm/15mm.

Seal material

- ▶ Grey silicone rubber.

Standard lengths

- ▶ 335mm, 435mm, 535mm, 635mm, 735mm, 835mm, 935mm, 1035mm, 1135mm and 1235mm.
- ▶ Note: Other lengths can be cut back to the next size down. The 535mm can be cut back to 495mm. The 335mm can be cut back to 255mm.

Fixing

- ▶ Pre-drilled end plates are supplied which also secure the product in place.
- ▶ Fixing screws are supplied.

Adjustment

- ▶ Self-levelling on uneven surfaces - can be adjusted independently of the fixing screws.

Finishes

- ▶ Silver anodised aluminium, grey silicone rubber gasket.
- ▶ Die cast end plates in square and radiused versions are available in a metallic finish.
- ▶ The non-button end cap is designed blank, creating an engineered smooth aesthetic.

DROP SEALS

LAS8040

MEDIUM DUTY 40dB

A medium duty, mortised automatic drop seal. The unique double activated mechanism has an adjustable brass striker button at the hinge side and a nylon striker at the latch side. The mechanism also contains additional internal seals and a double compression facility to provide exceptional acoustic performance. Can be used for both 44mm and 54mm doors.

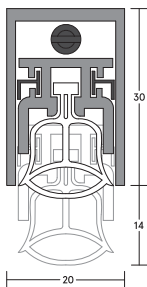

LAS8040



LAS8040 (shown with LAS4001)

DROP SEALS

SYSTEM SPECIFICATIONS

Test evidence

- ▶ Acoustic: BS EN ISO 10140-2: 2010 (up to Rw 40dB).

Performance

- ▶ Meets smoke requirement: BS 9999: 2017.
- ▶ Protects against sound, smoke, draught, light and insects.
- ▶ Suitable for wheeled traffic.

Location

- ▶ Single swing, single and double leaf doors.
- ▶ For use on both right and left handed doors.

Use with

- ▶ Any perimeter seal. Any threshold plate.

Min/max gap size

- ▶ 3mm/14mm.

Seal material

- ▶ Flexible thermoplastic elastomer gasket and internal fins.

Standard lengths

- ▶ 335mm, 435mm, 535mm, 635mm, 735mm, 835mm, 935mm, 1035mm and 1135mm.

- ▶ Note: Each size cuts back by 70mm.

Fixing

- ▶ Appropriate fixing screws are supplied, fixing holes are pre-drilled.
- ▶ Striker plates, which are located in the door jambs are supplied. This seal must be mortised.

Adjustment

- ▶ Self-levelling on uneven surfaces - can be adjusted independently of fixing screws.

Finish

- ▶ Silver anodised aluminium with black flexible gasket.

DROP SEALS

LAS8060

MEDIUM DUTY

A grade 304 stainless steel, medium duty automatic drop seal. It features a high efficiency mechanism, which lifts the seal clear of the floor as soon as the door is opened by a few millimetres; resulting in lower door operating forces. Requires no power connection.



DROP SEALS

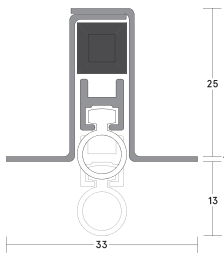

LAS8060



LAS8060
(shown with LAS4050)

SYSTEM SPECIFICATIONS

Performance

- ▶ Meets smoke requirement: BS 9999: 2017.
- ▶ Protects against sound, smoke, draught, light and insects.
- ▶ Suitable for wheeled traffic.

Location

- ▶ Single swing, single and double leaf doors.
- ▶ For use on both right and left handed doors.

Use with

- ▶ Any perimeter seal. Any threshold plate.

Min/max gap size

- ▶ 3mm/13mm.

Seal material

- ▶ Thermoplastic elastomer.

Lengths

- ▶ 725mm, 825mm, 925mm and 1025mm.
- ▶ Note: Each length can be reduced for an exact fit by up to 110mm.

Fixing

- ▶ Fixing screws are supplied, fixing holes are pre-drilled. Striker button, which locates in the door jamb, is supplied.
- ▶ End plates not supplied.

Adjustment

- ▶ Self-levelling on uneven surfaces. Adjustment can be carried out independently of the fixing screws.

Finish

- ▶ Stainless steel with grey thermoplastic elastomer gasket.

DROP SEALS

LAS8070

HEAVY DUTY

A grade 304 stainless steel heavy duty automatic drop seal. It features a high efficiency mechanism, which lifts the seal clear of the floor as soon as the door is opened by a few millimetres; resulting in lower door operating forces. Requires no power connection. Impervious to most chemicals, solvents, cleaning fluids and disinfectants.

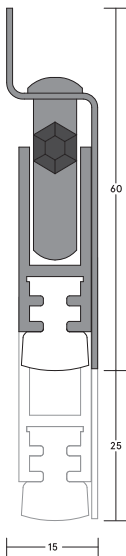

▲ LAS8070

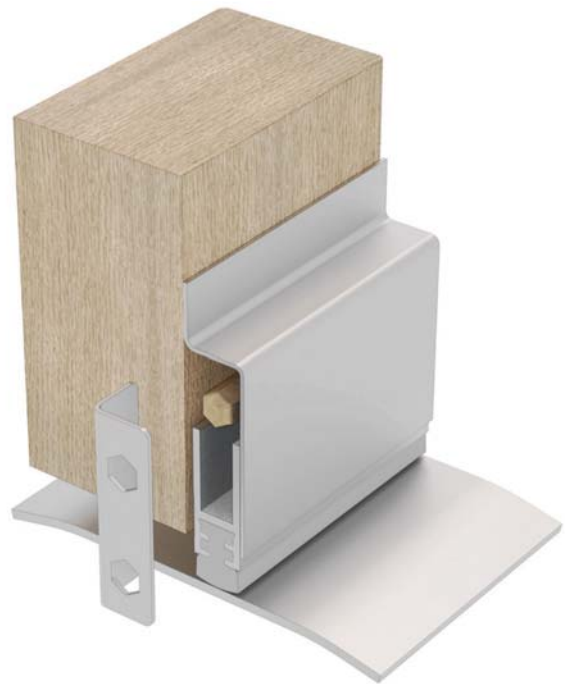

▲ LAS8070 (shown with LAS4055)

DROP SEALS

SYSTEM SPECIFICATIONS

Performance

- ▶ Suitable for use on timber fire doors.
- ▶ Protects against sound, smoke, fire, draught, light and insects.
- ▶ Suitable for wheeled traffic.

Location

- ▶ Single swing, single and double leaf doors.
- ▶ For use on both right and left handed doors.

Use with

- ▶ Any perimeter seal. Any threshold plate.

Min/max gap size

- ▶ 1mm/25mm.

Seal material

- ▶ Foamed silicone rubber.

Standard lengths

- ▶ 610mm, 710mm, 815mm, 915mm, 1015mm, 1120mm and 1220mm.
- ▶ Note: 610mm and 710mm length can be cut back by 80mm. All other lengths can be cut back by 100mm.

Fixing

- ▶ Fixing screws are supplied, fixing holes are pre-drilled. Striker button, which locates in the door stop, is supplied.
- ▶ End plates are supplied.

Adjustment

- ▶ Self-levelling on uneven surfaces. Adjustment can be carried out independently of fixing screws.

Finish

- ▶ Brushed stainless steel with grey silicone rubber insert.

▼

FINGER GUARDS / SPECIALITY SEALS

A range of speciality seals that features finger guards and drip guards.

Trapping fingers in hinged doors can cause horrendous injuries.

The risk is especially high where young children are present. Our finger guard seals provide a shield, helping prevent thousands of accidents.



LAS9001

MEDIUM DUTY

An overhead drip guard designed to channel rain water away from exposed doors, particularly those which open outward. Can also be used to deflect rainwater from the bottom of the door.

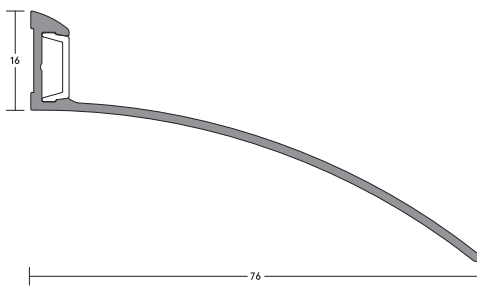

LAS9001



SPECIALITY SEALS

SYSTEM SPECIFICATIONS

Performance

- ▶ Protects against weather/rain.

Location

- ▶ Single and double leaf doors.
- ▶ Sliding doors.
- ▶ Roller shutter doors.
- ▶ Up and over doors.

Seal material

- ▶ Extruded aluminium.

Standard lengths

- ▶ 1m and 2.1m.

Fixing

- ▶ Steel screws are supplied (self-drilling and self-tapping screws for metal construction available on request).
- ▶ A PVC cover strip conceals the fixings.
- ▶ Allow an overlap of 50mm on each side of door opening.

Finish

- ▶ Silver anodised aluminium.

SPECIALITY SEALS

LAS9005

MEDIUM DUTY

A drip guard designed to channel rain water away from the bottom of exposed doors. Use with LAS9001 at the top of the door. Aesthetic anodised aluminium finish. Easy to fit. Concealed fixings.



SPECIALITY SEALS

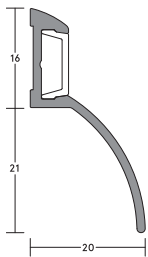

LAS9005



LAS9005
(shown with LAS4010)

SYSTEM SPECIFICATIONS

Performance

- ▶ Protects against weather/rain.

Location

- ▶ Single and double leaf doors.
- ▶ Roller shutter doors.
- ▶ Up and over doors.

Seal material

- ▶ Extruded aluminium.

Standard lengths

- ▶ 1m and 2.1m.

Fixing

- ▶ Steel screws are supplied (self-drilling and self-tapping screws for metal construction available on request).
- ▶ A PVC cover strip conceals the fixings.

Finish

- ▶ Silver anodised aluminium.

FLUSH BOLT DROP SEAL

LAS9010 / LAS8001 si

MEDIUM DUTY **41dB**

An innovative, slimline flush bolt that seamlessly integrates with our most popular drop seal – LAS8001 si. The flush bolt is a security device to be used on pairs of doors to secure the inactive leaf. It is activated by a discreet Lorient branded lever, that drops the bolt into a sleek keep in the floor. Specifically designed for use with our rebated high performance drop seal; together they provide the ultimate system combining security, with acoustic, smoke and energy containment at the bottom of the door.



FINGERGUARDS / SPECIALITY SEALS

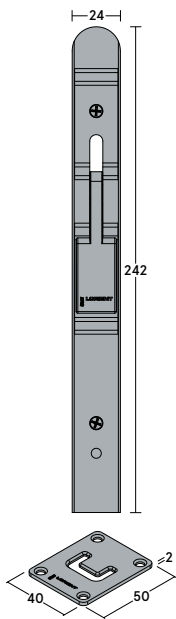

LAS9010



Unlocked



Locked

Patent applied for No. 1718821

SYSTEM SPECIFICATIONS

Test evidence

- ▶ Maintains acoustic performance of drop seal 41dB (BS EN ISO 10140-1: 2010+A2: 2014, Annex J).
- ▶ Fire: BS 476-20/22: 1987 in an FD30.*
- ▶ Fire: BS 476-20/22: 1987 in an FD60.*
- ▶ Fire: BS EN 1634-1: 2008 in an FD60†
- ▶ Classified to BS EN 12051: 2000.
- ▶ Durability: 50,000 cycles.

Performance

- ▶ Protects against sound, smoke, fire, draught, light + insects (LAS8001 si).
- ▶ LAS9010 is a security device. Its unique wrap-around shape of bolt enhances security.
- ▶ Flush bolt integrates seamlessly with the drop seal; no extra kits required.
- ▶ Smooth locking action with branded levers.
- ▶ Does not penetrate the drop seal gasket.

Min/max gap size

- ▶ 1mm/13mm.

Location

- ▶ Double swing doors.
- ▶ For use on both right + left handed doors.
- ▶ Suitable for bottom + top of the door.

Material

- ▶ Flush bolt – brushed stainless steel.
- ▶ Seal material – grey or black silicone rubber.

Drop seal standard lengths

- ▶ 335mm, 435mm, 535mm, 635mm, 735mm, 835mm, 935mm, 1035mm, 1135mm + 1235mm.
- ▶ Note: each length can be cut to the next size down. The 335mm can be cut back to 255mm.

Fixing

- ▶ LAS9010 is semi-mortised onto the top + bottom of the door.
- ▶ Fixing screws are supplied.
- ▶ Flush bolt is positioned into the keep.
- ▶ Drop seal end plate is not required.
- ▶ No extra adapter kits required.

Use with

- ▶ All standard lengths of LAS8001 si, with the ability to cut to size.
- ▶ *Cladding kits must be used for fire rated variants.
- ▶ †Subject to door leaf construction/ specifications + inclusion of cladding kit

LAS9030

MEDIUM DUTY

A durable safety finger guard seal, which provides a deterrent to fingers becoming jammed on the hinge cavity side of a door. The product is fixed to the door and the jamb on the hinge cavity side. Trapping fingers in hinged doors can cause horrendous injuries. The risk is especially high in locations where young children are present. To be used in conjunction with LAS9050 si finger guard seal for the hinge knuckle side.



SYSTEM SPECIFICATIONS

Test evidence

- ▶ Tested to BS 8613:2017 (Finger protection devices for pedestrian doors - Type A, Class 2).
- ▶ Durability: 300,000 cycles.

Performance

- ▶ Protects against draught and light.

Location

- ▶ Jambs of hinged doors. It can be used on doors with an opening of 170° when used with LAS9050 si. 180° can be obtained when LAS9030 is used on its own.

Use with

- ▶ LAS7001 si perimeter seal and LAS8001 si drop seal (fully mortised).

Seal material

- ▶ Black EPDM rubber.

Standard lengths

- ▶ 2.1m. Other lengths to special order.

Fixing

- ▶ Self-tapping wood screws are supplied (self-drilling and self-tapping screws for metal construction available on request)
- ▶ Fixing holes are pre-drilled and slotted to allow the seals to be adjusted and positioned accurately. PVC cover strips to conceal fixings are supplied.

Finishes

- ▶ Silver anodised aluminium with grey cover strip and black gasket.
- ▶ Bronze anodised aluminium with black cover strip and black gasket.

LAS9050 si & LAS9070 si

MEDIUM DUTY

This medium duty finger guard seal system provides a shield to trapping fingers in hinged doors, which can cause horrendous injuries. Protects both sides of the door by using the LAS9050 si on the hinge knuckle side and the LAS9070 si on the hinge cavity side.



FINGER GUARD SEALS

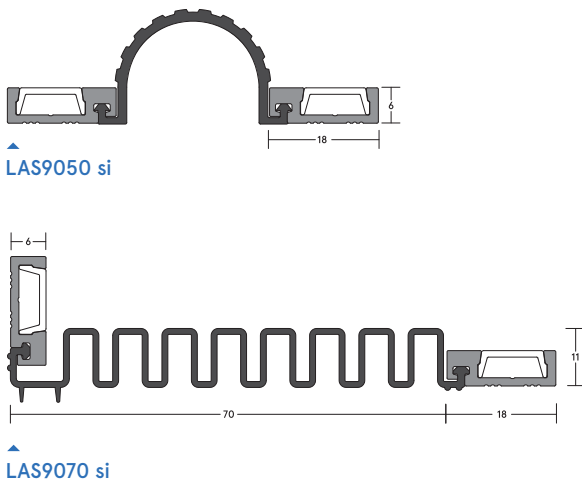

SYSTEM SPECIFICATIONS

Test evidence

- ▶ Tested to BS 8613:2017 (Finger protection devices for pedestrian doors - Type A, Class 1).

Performance

- ▶ Protects against draught and light.
- ▶ Suitable for wheeled traffic.

Location

- ▶ Jambs of hinged doors. LAS9070 si can be used on doors with an opening of 180°.

Use with

- ▶ LAS7001 si perimeter seal and LAS8001 si drop seal (fully mortised).

Seal material

- ▶ Silicone.

Standard lengths

- ▶ 2.1m. Other lengths to special order. Single doorset packs are available containing 1 x 2.1m LAS9050 si and 1 x 2.1m LAS9070 si.

Fixing

- ▶ Self-tapping wood screws are supplied (self-drilling and self-tapping screws for metal construction available on request).
- ▶ Fixing holes are pre-drilled and slotted to allow the seals to be adjusted and positioned accurately. PVC cover strips to conceal fixings are supplied.

Finishes

- ▶ Silver anodised aluminium with grey cover strip and grey gasket.
- ▶ Bronze anodised aluminium with black cover strip and black gasket. (Black, brown or cream gaskets are also available).

FINISHES INFORMATION

Our wide range of colours and finishes provides inspiration for all types of buildings; from luxurious and contemporary hotels, to bright and bold nurseries and schools – there's a perfect colour or finish available to suit every project.

We've recently added a number of stylish new finishes to our range of high performance architectural seals, which are available in either silver or bronze anodised aluminium as standard. Our new finishes are designed to provide creative freedom for the most discerning interiors; and include honey-toned and subtle light bronze; and a sophisticated, sleek, matte black. Please ask for bespoke project pricing and lead times on these specials.

An in-house, RAL colour matching service is also available for those wishing to coordinate seals with other architectural features, such as door furniture and trims. Special colours are created using a powder coated finish for a higher aesthetic or to complement bespoke interiors. All architectural seals are manufactured in Lorient's UK facility, to exacting standards and have been designed and developed to deliver the perfect combination of stylish looks and outstanding performance.

We extend our offering way beyond colour and finishes – specialising in assisting and developing customised solutions through collaboration with our customers. Utilising in-house expertise, custom-made products are created to suit customers' requirements.



ADDITIONAL INFORMATION

TECHNICAL REFERENCES

Lorient is quality assured under the disciplines of BS EN ISO 9001: 2015.

Accreditation to this standard is an assurance that we conduct our business to the complete satisfaction of our customers with regard to design solutions, manufacturing consistency and management procedures.

As a result, this internationally recognised standard for quality management generates customer confidence. Regular audits of our company procedures are undertaken by qualified BSI staff to ensure ongoing compliance with all aspects of the standard.



BS EN ISO 9001: 2015 Certificate No. Q6104

Lorient has attained the BS EN ISO 14001: 2015 accreditation for environmental management, making us the first seal manufacturer to have achieved this important award. This internationally recognised standard shows that we have demonstrated our commitment to responsible environmental behaviour, including prevention of pollution, control and reduction of waste, and ongoing monitoring and improvement of our environmental performance. Achieving ISO 14001 is just one part of our ongoing commitment to operate in a sustainable way.



BS EN ISO 14001: 2015 Certificate No. EMS 541906

FITTING INSTRUCTIONS

Comprehensive fitting instructions are included with each consignment; and are also available to download from our website www.lorientuk.com

MAINTENANCE

Periodic inspection and cleaning is recommended for all types of seals. The appearance and performance of seals will benefit from an annual wipe with a damp cloth. Seals should be checked for correct adjustment. Worn or damaged seals should be replaced immediately.

COMPATIBILITY

All Lorient Architectural Seals are compatible with the materials normally used in doors and door frames, including wood, steel, PVC, aluminium and glass.

Please Note: Recommendations as to methods, use of materials and construction details are based on the experience and knowledge of Lorient and are given in good faith as a general guide and a service to designers, contractors and manufacturers.

GUARANTEE OF ORIGIN

Each production batch of Lorient seals is laser engraved unobtrusively on the edge of the profile with the Lorient name and a code reference. This ensures the product and details of its production can be traced should the need arise.

Unidentifiable substitute products should never be accepted.

MADE IN BRITAIN

We are proud to have been granted the prestigious Made in Britain marque for our products, designed and manufactured at our main facility in South West of the UK.



TRADE ASSOCIATIONS

Lorient is a member and active contributor to the following:



ASSOCIATION OF COMPOSITE DOOR MANUFACTURERS



Qualifying Fire Door Professionals

ACCREDITATIONS

BBA

BBA approvals provide independent assurance for the designer, specifier and end-user as to the 'fitness for purpose' of building products.



CERTIFIRE

Operated by Exova Warringtonfire, CERTIFIRE is an accredited independent product conformity scheme that requires products to meet the requirements of the tests, to add minimal resistance to opening and closing forces, to prove long term performance under a variety of service conditions, and to be permanently marked for easy identification.



UL

UL is a global independent safety science company that tests a diverse range of products; representative samples of a product must be tested and meet UL's stringent requirements to carry the marque. These requirements are based primarily on UL's published and nationally recognised Standards for Safety. Businesses, consumers and regulatory authorities around the world recognise the trusted rigour and technical excellence of UL certifications. Lorient is proud to have achieved the UL Mark on many of its products. These are detailed on individual pages.



CPDs

We offer three fully-accredited CPD seminars. Impartially presented by knowledgeable speakers, the seminars are structured to be technically informative, and provide practical advice.



Performance Door Design: The Basics of Sound Reduction

Effective acoustic containment helps to improve the quality of the built environment, preserving privacy as well as excluding unwanted noise. With changing regulations, it's essential to be informed of the relevant requirements and the implications for door assemblies.

Our acoustic CPD seminar covers:

- ▶ the nature of sound, examining airborne transmission of sound;
- ▶ regulatory requirements and British Standards that relate to acoustic performance;
- ▶ test procedures and interpretation of test reports;
- ▶ effective design of door assemblies for acoustic performance, including door construction and the influence of sealing systems;
- ▶ design conflicts between acoustic performance, durability and ease of operation of the door;
- ▶ independent accreditation.

The Role and Performance of Fire and Smoke-Resisting Door Assemblies

The importance of fire and smoke resisting door assemblies is illustrated by the 303 fire related fatalities and 7,661 casualties in fires (2015/16). Apart from the human toll, property losses each year approach £2.52 billion.

Our fire and smoke containment CPD seminar covers:

- ▶ hard facts concerning deaths, injuries and property damage caused by fire and smoke;
- ▶ regulatory requirements for fire and smoke resisting door assemblies;
- ▶ the nature and behaviour of smoke;
- ▶ effective design of door assemblies for smoke containment, including the threshold gap;
- ▶ design conflicts between fire containment, smoke containment, durability and ease of operation of the door;
- ▶ independent accreditation.

The Regulatory Reform (Fire Safety) Order 2005 and its implications for fire doors

The RRO consolidated 70 pieces of legislation; shifted responsibility for fire safety management; abolished the Fire Safety Certificate; established the Fire Risk Assessment and created major change in legal liability.

Our RRO CPD seminar covers:

- ▶ an overview of the RRO;
- ▶ product solutions;
- ▶ the dangers of fire and smoke;
- ▶ the importance of fire doors – including installation and maintenance.

Our CPD materials have been independently verified and certified by the RIBA as CPD approved. A certificate for 1 hour's CPD will be provided, which contributes to Continuing Professional Development requirements.

If you are interested in booking a seminar, please contact our Marketing department or email cpd@lorientuk.com.



COMPREHENSIVE SUPPORT

We continue to lead the way in Research + Development. As a company we have almost 40 years' experience, so our experts are well equipped to listen, help and advise you on your sealing system requirements.

Technical Services

We're happy to provide specialist advice on acoustic, smoke and fire protection for refurbishment and new build projects. If you need assistance, you can call our Technical Services team.

Alternatively, we can arrange a site visit to get a clearer idea of your needs and how we can help you. We also provide copies of test reports and samples where needed; and can give guidance on how best to meet Building Regulations and Standards.

Fire Door Inspection Services

We also offer a professional and expert fire door inspection service. Our Certificated Fire Door Inspectors are fully qualified under the Fire Door Inspection Scheme (FDIS); and have been assessed by Exova Warringtonfire, an independent third party. They are certificated to carry out the inspection of your building's fire doors and prepare a detailed survey and report on the condition and function of the fire doors on your premises. This is invaluable if you're a Responsible Person in a building. Contact us for more details.



Web Support

Our website features a comprehensive range of supporting documents covering the entire range of products, including installation guides and CAD drawings. All of our brochures and products sheets are also available for download, together with copies of certification and specification texts.

Online Acoustic Search tool

Our Acoustic Search tool on our website gives you quick and easy access to a wide range of tested acoustic sealing systems on a variety of popular door constructions & configurations.

www.lorientuk.com/acousticsearch

The tool allows users to select a specific decibel rating; along with door configuration, fire door rating, doorset type etc to filter the results. The 'Acoustic Search' tool is updated frequently with Lorient's ever-expanding portfolio of test evidence. If you're looking for high performance or specialist applications – please contact us on **+44 (0) 1626 834252**, there may be some additional configurations we haven't yet published.



Customisation

If you have a particular requirement which isn't covered by the applications in this brochure, we may be able to supply an existing non-standard item, or even develop a customised solution for you. Utilising in-house expertise, bespoke products are created to your requirements; from a functional or aesthetic perspective, or both.

Lorient's dedicated Technical Services team supports and works as part of your design team, offering informed product advice and guidance on regulatory requirements and standards.



**Call our Technical
Services team**
+44 (0) 1626 834252

www.lorientuk.com

COMPRESSION SEALS

(PAGES 8–13)

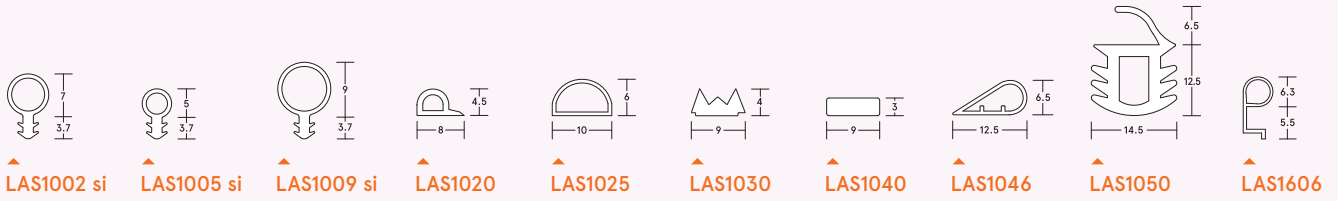

DOOR BOTTOM SEALS

(PAGES 14–21)

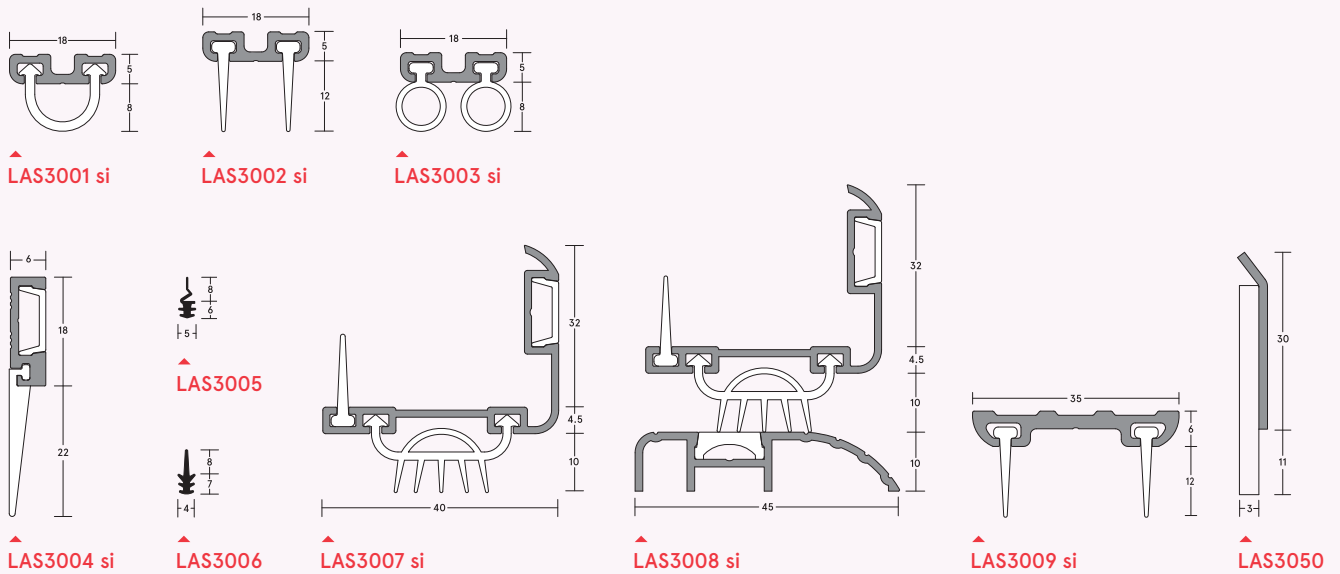

PERIMETER SEALS

(PAGES 37–45)

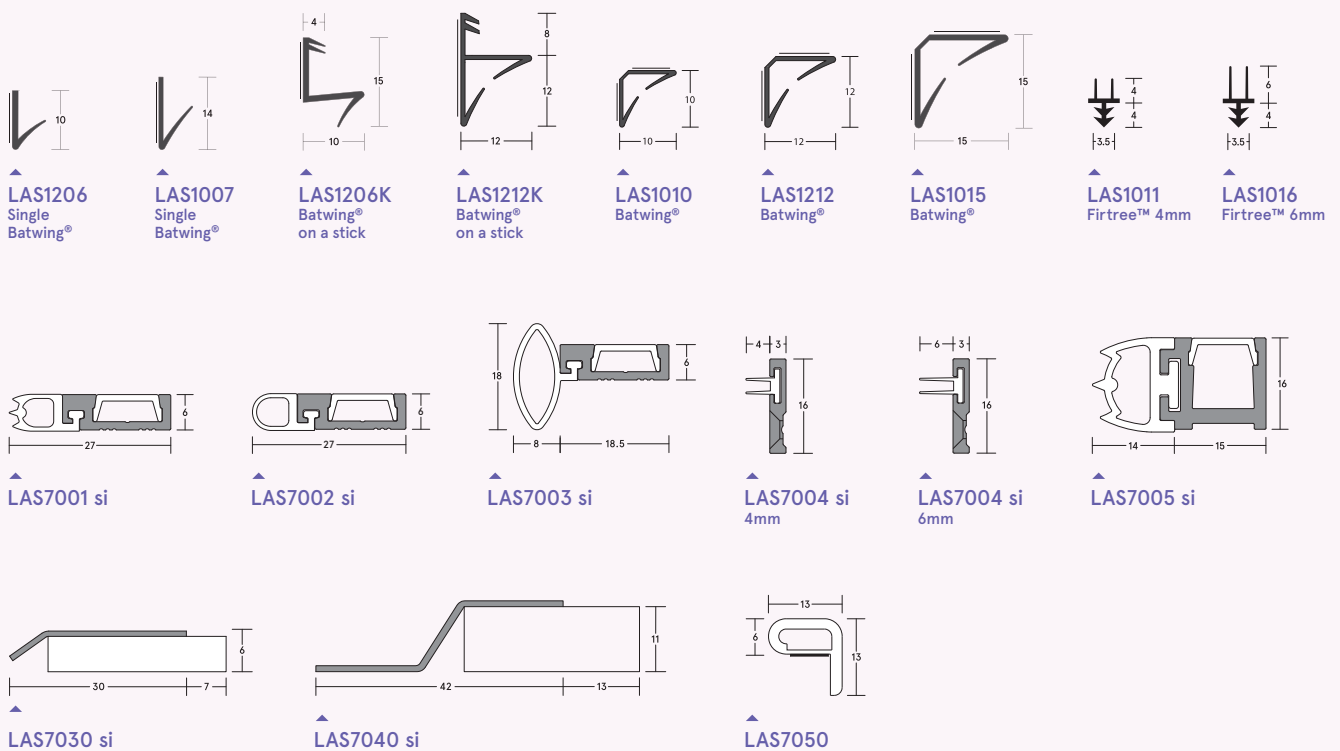

THRESHOLD PLATES + RAMPS

(PAGES 22–28)



LAS4001

LAS4002

LAS4010



LAS4011



LAS4012



LAS4013



LAS4014 si



LAS4015

LAS4050



LAS4055



LAS4100

MAGNETIC SEALS

(PAGES 34–36)

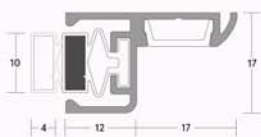

LAS6001



LAS6011

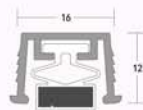

LAS6002

BRUSH SEALS

(PAGES 29–33)



LAS5020

Also available

LAS5010 (13mm brush)
LAS5015 (19mm brush)
LAS5025 (35mm brush)
LAS5030 (45mm brush)



LAS5035

Also available

LAS5040 (60mm brush)
LAS5045 (80mm brush)
LAS5050 (120mm brush)
LAS5055 (150mm brush)

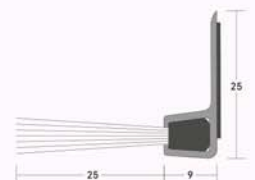

LAS5060

Also available

LAS5065 (35mm brush)
LAS5070 (45mm brush)



LAS5075

Also available

LAS5080 (35mm brush)
LAS5085 (45mm brush)

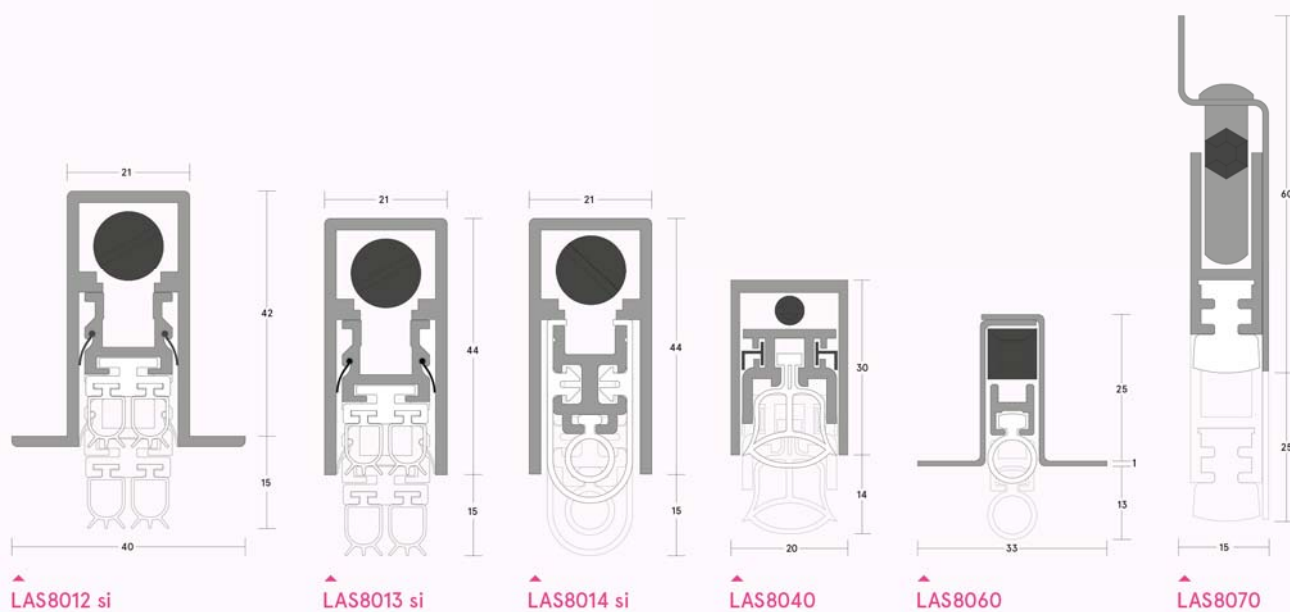
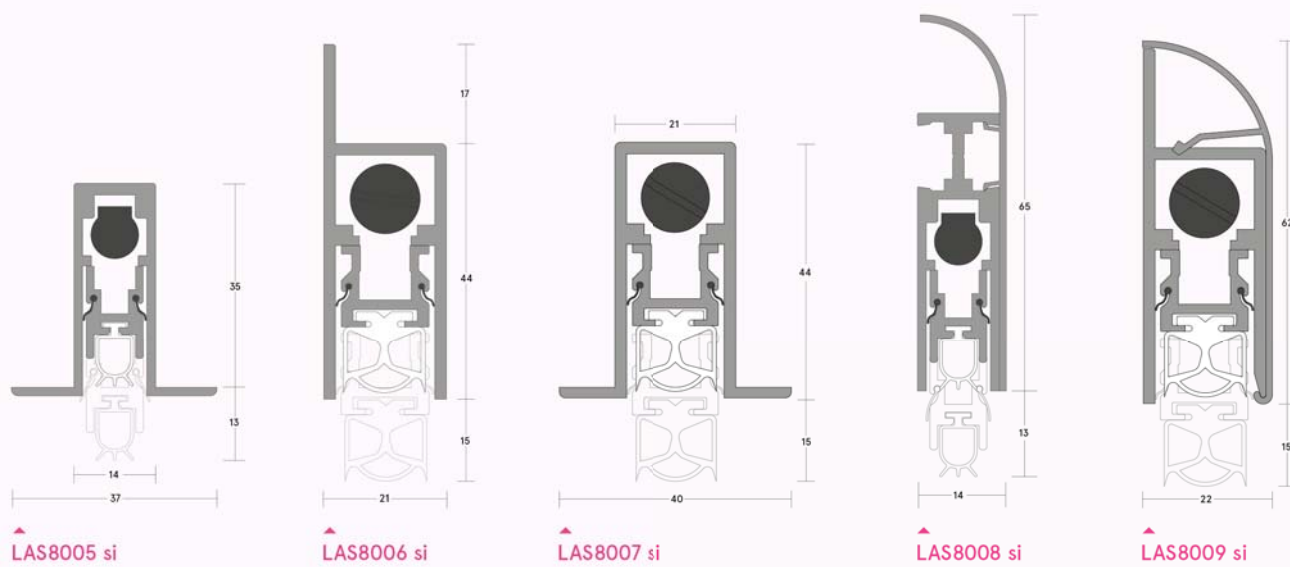
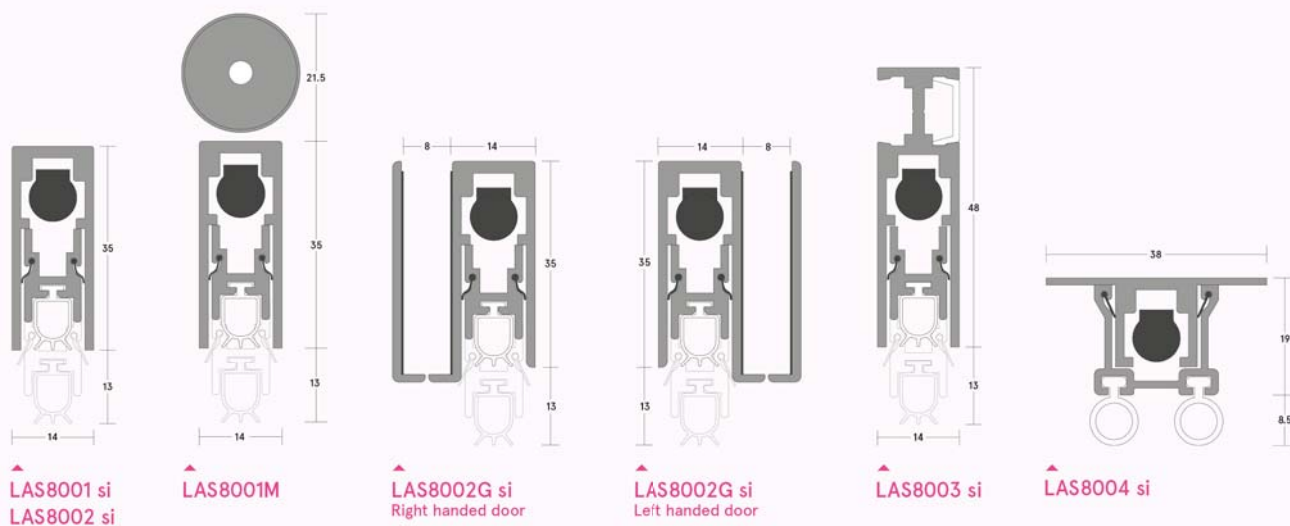



▲ LAS9030



▲ LAS9050 si

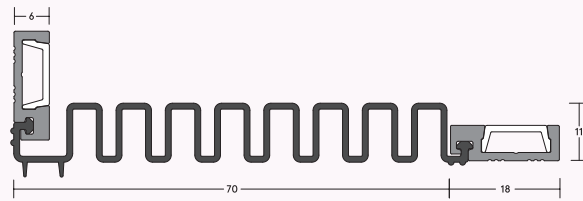

▲ LAS9070 si

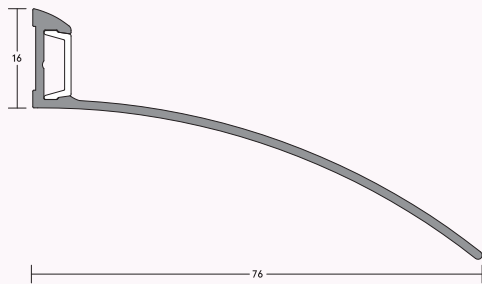

▲ LAS9001

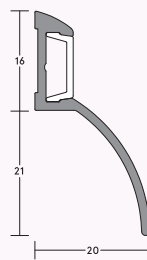

▲ LAS9005

ARCHITECTURAL SEALS

PRODUCT ILLUSTRATIONS

All dimensions in this brochure are in millimetres.

Please note illustrations are not to scale and for reference only.



UK / EUROPE

T: +44 (0) 1626 834252
F: +44 (0) 1626 833166
E: mktg@lorientuk.com

AUSTRALIA

T: +61 (02) 9907 6221
E: sales@lorientau.com.au

HONG KONG

T: +852 2505 0328
F: +852 2505 0332
E: sales@lorienthk.com

SINGAPORE

T: +65 6270 1279
E: sales@lorient.com.sg

UAE

T: +9714 883 7206
F: +9714 883 7207
E: sales@lorientgulf.ae

USA

T: +1 859 252 7441
F: +1 859 381 1241
E: inquiries@lorientna.com

R A L

For further information about
Lorient products please visit:
www.lorientgroup.com



@LorientUK



/company/lorient



@lorientuk



/LorientPolyproducts